

NOT  
an official  
Amstrad  
publication!!

THE MOULD-BREAKING MAGAZINE FROM FUTURE PUBLISHING

# AMSTRAD ACTION

## SMALL BUSINESS - BIG NEWS



Special feature on why the CPC is good news for small businesses and what it could do for you

## FLY HIGH - RUN DEEP

Dreams come true in the world of simulators, from submarines to spacecraft we've covered them all

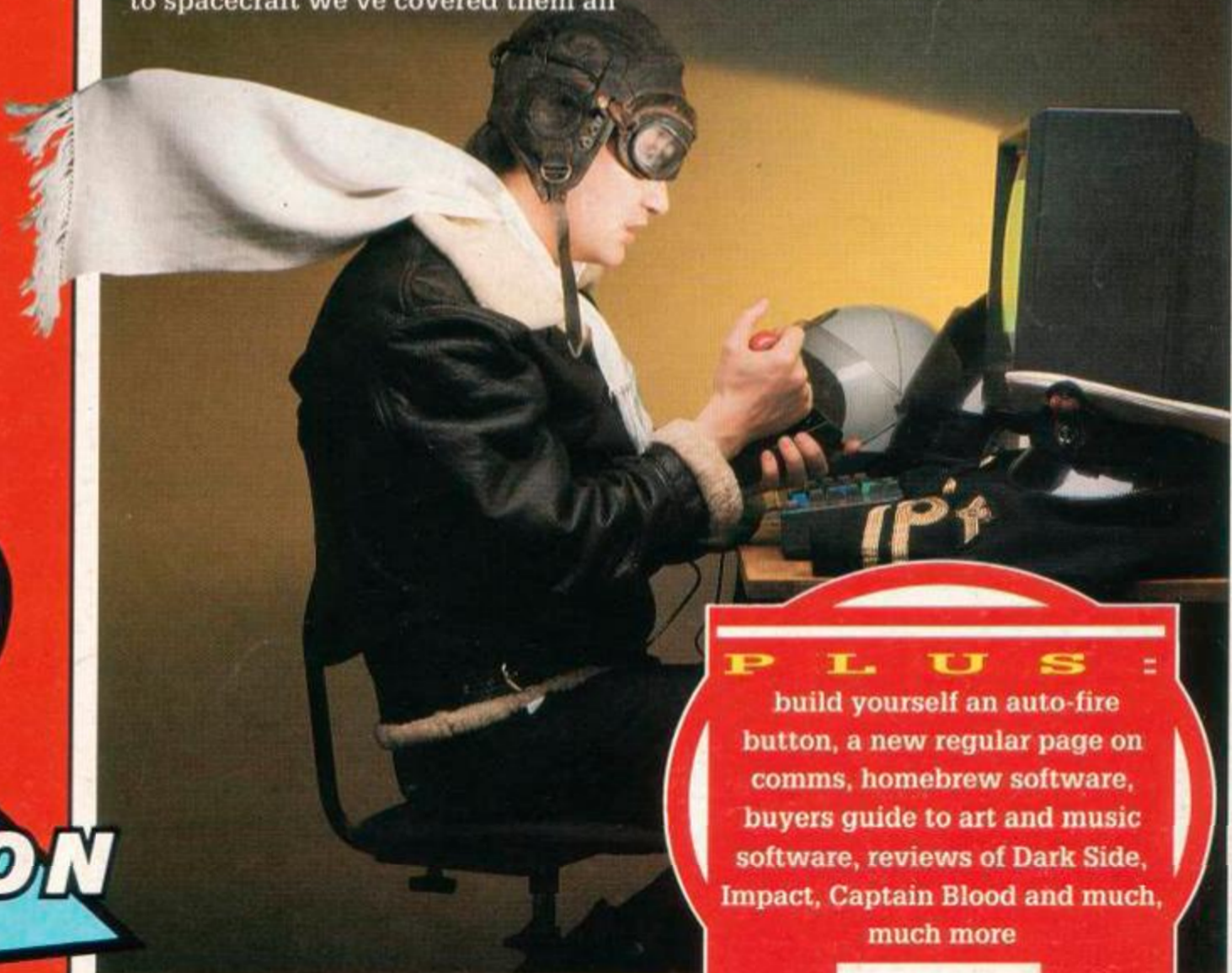

### PLUS =

build yourself an auto-fire button, a new regular page on comms, homebrew software, buyers guide to art and music software, reviews of Dark Side, Impact, Captain Blood and much, much more



# ACADEMY RIVALRY

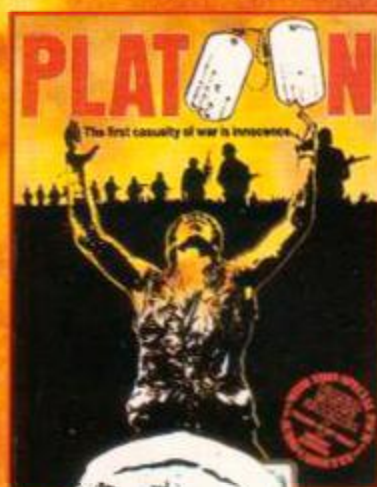

# JU WA



Konami's arcade hit now for your home micro and already a No. 1 hit. Seven gruelling events featuring the Assault Course, Firing Range, Arm Wrestling and Combat with the instructor himself! Combat school throws down the challenge to the toughest of thoroughbred gamers - but if you don't make the grade you're out!

© 1987 Konami

## PLATOON

Special boxed pack containing FREE film poster, game and audio cassette of Smokey Robinson's "Tracks". Capturing the intimidating mood of conflict with Platoon has been hailed as "Best Film Tie-In to date". Lead your Platoon deep into enemy territory, you feel the humidity, sense the threatening dangers and encounter the enemy and his many booby traps. Ha at your peril! Enemy soldiers lunge at you from the can find vital information. If you come out of this

© 1986 Hemdale Film Corporation. All Rights Reserved

# GAMES OF COMBAT, F

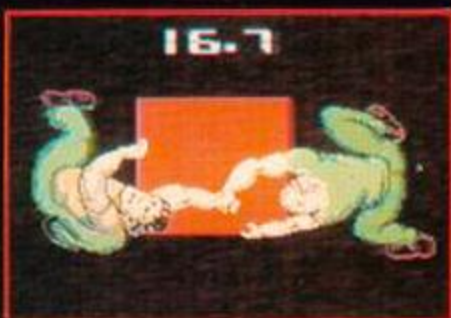

**COMBAT SCHOOL**  
SPECTRUM AMSTRAD  
**7.95 8.95**  
SPECTRUM COMMODORE  
ALSO AVAILABLE ON  
AMIGA & PC+ COMPATS.  
**PLATOON**  
SPECTRUM  
**9.95** COMMODORE  
ASTRAD



Ocean Software Limited · 6 Central Street · Manchester

# JUNGLE WARFARE

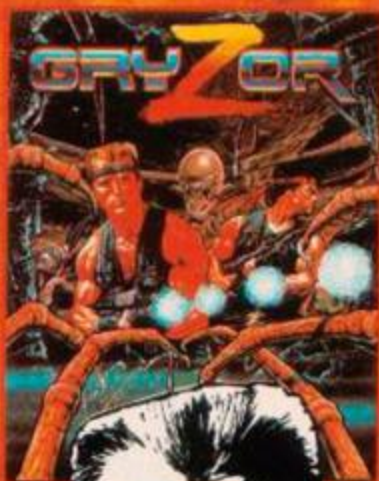

# SCI-FI SURVIVAL



## GRYZOR

A superb conversion for your home micro of Konami's arcade blockbuster. Featuring all the game-play of the arcade original, Gryzor takes you into a thrilling alien world of force fields, fanatical guerillas and strange enemy defence systems - but you have the fire-power and maybe, with a 'little' skill, grit and split second timing, you can infiltrate the aliens' headquarters. Play Gryzor once and you'll be hooked!



© 1987 Konami

# FIT ONLY FOR HEROES



**GRYZOR**  
SPECTRUM AMSTRAD  
**7.95 8.95**  
SPECTRUM COMMODORE  
ALSO AVAILABLE ON  
AMIGA & PC+ COMPATS.  
**PLATOON**  
IS ALSO AVAILABLE ON  
ATARI ST, AMIGA &  
PC+ COMPATIBLES



# THE LINE-UP

AMSTRAD ACTION JULY 1988

## FRONT END

NEWS●LETTERS

### 07 REACTION

The section where you have your say about life, the universe, CPC's, the mag and everything.

### 10 HELPLINE

Don't despair, help is at hand. The helpline can solve just about any problem. Go ahead - make their day.

### 12 AMSCENE

The latest news from the CPC scene, including the results of the latest questionnaire.

## SERIOUS SIDE

SOFTWARE●HARDWARE●PROGRAMMING

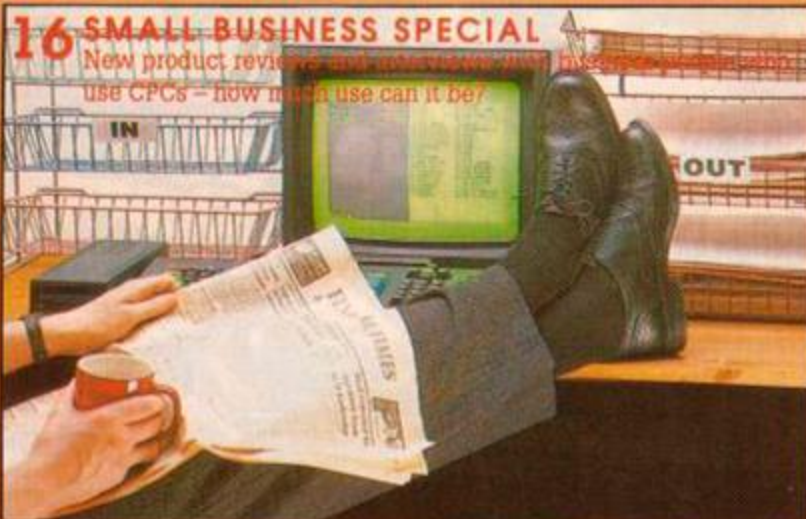

### 20 WORDS WORK

The section where we try to help you get the most from your word-processor and printer.

### 22 ABSOLUTE BEGINNERS

Our tutorial on how to go from complete computer ignorance to complete mastery of Basic.

### 22 FIRST BYTES

A beginners guide to the delights of machine code. There's even something for more advanced hackers.

### 27 HARDWARE PROJECT

Following on from last month's succesful projects we've got another one - this time for a joystick autofire.

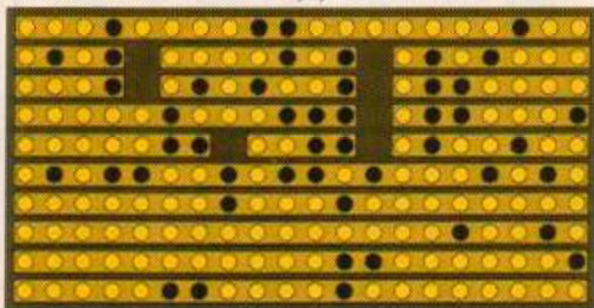

### 28 HOMEBREW SOFTWARE

There's a thriving underground of people producing their own software and selling it. We've taken a look at the best of it.

### 31 COMMS

A new regular page in which we delve into the world of comms with reviews, news and views.

### 27 HARDWARE REVIEWS

A sound sampler from over the channel, yet another version of the Multiface, and a new ROM and interface for modem users.

### 30 BAR CPM

In which we explore the delights of CPM software, its commands and public domain software.

### 34 SERIOUS SOFTWARE REVIEWS

We've reviewed *Lisp*, the latest language from HiSoft, and *Rodos Extra*, the enhancement for the Rodos ROM.

### 32 PROBLEM ATTIC

If disaster strikes and you need a helping hand, our trusty expert is never at a loss for words.

## ACTION & ADVENTURE

GAMES●MAPS●PILGRIM

### 41 ACTION TEST STARTS HERE

### 41 EDDIE EDWARDS' SUPER SKI

The most famous sporting failure Britain's ever had, lends his name to a new winter sports game.

### 42 DARK SIDE — MASTERSGAME

The follow up to the immensely succesful *Driller* is just as impressive and grabs the same award.

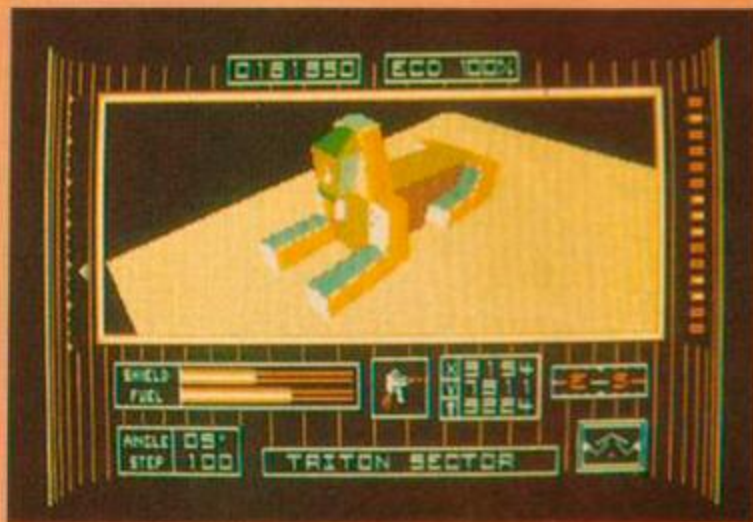

### 40 CAPTAIN BLOOD

A graphically superb romp through the galaxy in a search and destroy mission for clones of yourself

### 40 IMPACT

Yet another Breakout clone and in our view the best of the bunch. Lots more balls to send everybody bonkers.

## 57 SIMULATORS

A special feature on simulators of all kinds from the space shuttle and jet fighters to grand prix cars and motor bikes



## 59 THE PILGRIM

The Pilg hides his tan under his cowl and gets back to the serious task of providing the best coverage of adventuring on the CPCs.

## INTERACTION

CREATED BY YOU AND FOR YOU

## 32 HOT TIPS

Discovered handy hints for your programs? Here's the place to send them so everyone else can use them.

## 54 CHEAT MODE

Take your games to the outer limits with our pokes and playing tips. Some pokes may even take you into the twilight zone.

## 62 TYPE-INS

Now everyone can have a crack at running a magazine with a great listing. Plus games, utilities and curiosities.

## WRAPPING UP

THINGS TO BUY • BYE

## 67 CLASSIFIED ADS

You can use this direct link to tens of thousands of CPC owners, and all for just £5.

## 68 BUYERS GUIDE

This month we recommend the best in art and music, to make your CPC make sweet music and enchanting pictures.

## 70 SPECIAL OFFERS

Outstanding offers on new software you've just got to get. Don't miss out on our, as ever, excellent subscription offer.

## 74 REAR VIEW

A slanted look at the computer world

# Pastures New

After 34 issues of AA, as software editor, deputy editor and for the last 17 issues as editor, I'm moving on to a new challenge. Roaring into action next month will be Steve Carey, who after sterling service elsewhere at Future Publishing is taking over as editor.

I'm off to work on our sister magazine Advanced Computer Entertainment, so I'll still be around to see how the new ed is doing. Doubtless he'll wrinkle out all those naughty typo's which I let through.

It's been a fantastic three years working on AA and I hope you've all enjoyed reading the mag as much as I have writing it. I've watched it grow from a pretty amateurish first issue into a very professional, entertaining mag. It also started the whole of Future Publishing going, which now boasts six impressive titles - all the envy of many rival publishers.

I shall miss the "club" feeling that goes along with AA. The CPC market is unique in its spread of users from the very young word-processing fan to the retired game addict. That brings a special feel to AA because it's the users that determine most of what actually appears in its pages.

The mag is in good hands with Steve, Ollie, Pat and Gary who will continue to meet the high standards you expect of AA, and I'm sure they'll be able to improve on it. (That's enough sentimental stuff - ed). I'm glad to be going out on a high note with an excellent issue and there are plenty more to come!

Bob

Amstrad Action  
Future Publishing Limited  
4 Queen Street  
Bath BA1 1EJ

Telephone 0225 446 034  
Fax 0225 446 019

Editor: Bob Wade

Technical Editor: Pat McDonald

Staff Writer: Gary Barrett

Art Editor: Ollie Alderton

Contributors: Richard Monteiro, Steve Cooke

Art Team: Sally Meddings, Kevin Hibbert

Publisher: Chris Anderson

Production: Diane Tavener, Jenny Evans, Claire Woodland

Subscriptions: Avon Direct Mail  
PO Box 1, Portishead, Bristol BF20 9EG  
Telephone 0272 842487

Mail Order: Clare Bates  
The Old Barn, Brunel Precinct, Somerton, Somerset TA11 7PY  
Telephone 0458 74011

Advertisements: Margaret Clarke  
Byrom House, 58 Brinksway, Stockport, Cheshire  
Telephone 061 474 7333

Cover photographs: Stuart Baynes Photography, Bath. Tel: 0225 66343  
Colour origination: Wessex Reproductions, 325 Wells Road, Bristol BS4 0QL  
Printing: Redwood Web Offset, Yeomans Way, Trowbridge, Wilts

Distribution: Seymour Press, 334 Brixton Road, London SW9 7AG  
Netherlands distribution and subscriptions: Info-Data Computers, Postbus 97, 3800AB Amersfoort.

© FUTURE PUBLISHING LTD 1988  
Amstrad Action is an independent publication. The company producing it - Future Publishing Ltd - has no connection with Amstrad plc. We welcome contributions from readers but unfortunately cannot guarantee to return material submitted to us, nor can we enter into personal correspondence. We take great care to ensure that what we publish is accurate, but cannot be liable for any mistakes or misprints. No part of this publication may be reproduced in any form without our permission.

AMSTRAD  
ACTION

# Lots of nice programs from ARNOR

## Amstrad CPC Games

		cass	disc			cass	disc			cass	disc
2nd City	Novagen	7.86		Get Dexter II	Infogrames	7.86	11.81	They Sold a Million	Ocean	7.86	11.81
6 Pack	Elite	7.86	11.81	Grand Prix 500cc	Loriciels	7.89	11.84	They Sold a Million 2	Ocean	7.86	11.81
6 Pack Vol. 2	Elite	7.86	11.81	Gryzor	ocean	7.07	11.81	They Sold a Million 3	Ocean	7.86	11.81
720	U S Gold	7.89	11.84	Guild of Thieves	Rainbird		15.76	Thrust 2/Parabola	Firebird		5.52
A.T.F.	D. Integration	7.07	11.02	Harvey Head/Willow	Firebird		5.52	Thrust/Ninja Master	Firebird		5.52
Ace of Aces	U S Gold	7.89	11.84	Hitchhikers Guide	Infocom		19.74	Thundercats	Elite	7.86	11.81
Acrojet	Microprose	7.86	11.81	Hollywood HI	Infocom		19.74	Tobruk	P S S	7.86	11.81
Allens (Electric)	Electric Dreams	7.89	11.84	Indiana Jones	U S Gold	7.86	11.84	Tomahawk	Digital Int	7.86	11.81
Allens (U S Version)	Activision	7.89	11.84	Infidel	Infocom		19.74	Top Ten Collection	Elite	7.89	11.84
All New Blockbusters	Domark	6.28	11.81	International Karate	Prism Leisure		5.52	Tour De Force	Gremlin	7.89	11.81
Andy Capp	Mirrorsoft	7.86	11.81	International Karate +	Activision	7.89	11.84	Tournament Of Death	Infogrames	7.86	11.81
Annals of Rome	P S S	10.23	14.18	Jack the Nipper 2	Gremlin	7.89	11.84	Trantor	Gol	7.89	11.84
Arkanoid	Imagine	7.07	11.81	Jackal	Nemsis	7.07	11.81	Trapdoor II	Piranha	7.07	11.02
Armageddon Man	Martech	10.23		Jewels Darkness	Rainbird	11.81	15.76	Trivial Baby Boomer	Domark	11.81	15.76
Barbarian	P V G	7.89	10.23	Joe Blade/Dizzy Dice	Players		5.52	Trivial Genius Edition	Domark	11.81	15.76
Basil - Great Detect	Gremlin	7.89	11.84	Kids Play	Power House	7.89		Trivial Young Edition	Domark	11.81	15.76
Basket Master	Imagine	7.07	11.81	Killed Until Deed	U S Gold	7.89	11.84	Two on Two Basketball	Activision	7.89	11.84
Battle For Midway	P S S	7.86		Knight Orc	Rainbird	11.80	15.76	Ultima Ratio/Gunstar	Firebird		5.52
Battle of Britain	P S S	7.86		Knightmare	Activision	7.89	11.84	Unitrax	Domark	7.07	11.81
Battlefield Germany	P S S	10.23	14.18	Konami Arcade Coll	Imagine	7.86	11.81	Vulcan	C C S	7.86	
Bedlam	Gol	7.89	11.84	Konami Coin-Ops	Imagine	7.86	11.81	Western Games	Ariolasoft	7.86	11.84
Big 4 Compilation	Durell	7.86	9.44	Krypton Factor	Domark	6.28		Winter Games	U S Gold	7.86	11.81
Big 4 Vol. 2	Durell	7.86	11.81	Leaderboard	U S Gold	7.86	11.81	Wonderboy	Activision	7.89	11.84
Blood Valley	Gremlin	7.89	11.84	Leaderboard add on	U S Gold	3.94	7.89	World Class Leaderbd	U S Gold	7.89	11.84
Blue War	Gol		11.84	Leather Goddess	Infocom		19.74	World Games	U S Gold	7.89	11.84
Bobsleigh	D.Integration	7.86	11.81	Lee Enfield	Infogrames	7.86	11.81	Xor	Logotron	7.86	11.81
Bombjack 2	Elite	7.07	11.81	Little Comp People	Activision		11.84	Yes Prime Minister	Mosaic	11.81	15.76
Boulderdash Cons Set	Databyte	7.86	11.81	Live Ammo	Ocean	7.86	11.81	Yogi Bear	Piranha	7.86	11.81
Brainstorm	Firebird	1.57		Living Daylights	Domark	7.86	11.81	Zork 2	Infocom		19.74
Bravestarr	Gol	7.89	11.84	Lucas Film Comp	Activision	7.89	11.84				
Brian Clough Football	C D S	11.81	14.18	Lurking Horror	Infocom		19.74				
Bubble Bobble	Firebird	7.07	11.81	Mad Balls	Ocean	7.07	11.81				
Buggy Boy	Elite	7.86	11.81	Magnificent 7	Ocean	7.86	14.18				
Bulls-Eye	Domark	6.28		Mask	Gremlin	7.89	11.84				
California Games	U S Gold	7.89	11.84	Mask II	Gremlin	7.89	11.84				
Captain America	Gol	7.89	11.84	Masters Of Univ(Movie)	Gremlin	7.89	11.84				
Chain Reaction	Elite	5.52	10.26	Matchday II	Ocean	7.07	11.81				
Chamonix Challenge	Infogrames	7.86	11.81	Mercenary	Novagen	7.86					
Championship Football	Activision	7.89	11.84	Mercenary Comp	Novagen		15.76				
Championship Sprint	Activision	7.89	11.84	Metrocross	U S Gold	7.89	11.84				
Ciuedo	Leisure Genius	7.86	11.81	Miss Gen/Bomb scare	Firebird		5.52				
Colossus Bridge	C D S	9.44	11.81	Monopoly	Leisure Genius	7.86	11.81				
Colossus Chess 4	C D S	7.86	11.02	North Star	Gremlin	7.89	11.84				
Colossus Mah Jong	C D S	7.89	11.84	Out Run	U S Gold	7.89	11.84				
Combat School	Ocean	7.07	11.81	Paperboy	Elite	7.07	11.81				
Compendium	Gremlin	7.89	11.84	Pawn	Rainbird		15.76				
Computer Classics	Beau Jolly	5.52	7.89	Pegasus Bridge	P S S	10.23	14.18				
Computer Hits 2	Beau-Jolly	7.86	11.81	Phantom Club	Ocean	7.07	11.81				
Computer Hits 3	Beau-Jolly	7.86	11.81	Planetfall	Infocom		19.74				
Computer Hits 4	Beau-Jolly	7.86	11.81	Pistoon	Ocean	7.86	11.81				
Computer Hits 5	Beau-Jolly	7.86	11.81	Predator	Activision	7.89	11.84				
Computer Hits 10	Beau-Jolly	7.86		President	Prism Leisure		6.31				
Conflicts	P S S	10.23	14.18	Prohibition	Infogrames	7.86	11.81				
Corporation	Activision	7.89	11.84	Psycho Soldier	Ocean	7.07	11.81				
Countdown	Domark	6.28		Pub Games	Alligata	6.31	7.89				
Dan Dare II	Virgin	6.28	11.81	Rampage	Activision	7.89	11.84				
De Luxe Scrabble	Leisure Genius		12.80	Ramparts	Gol	7.89	11.84				
Deadline	Infocom		19.74	Renegade	Imagine	7.07	11.81				
Death Wish 3	Gremlin	7.89	11.84	Revenge Of Doh	Imagine	7.07	11.81				
Deeper Dungeons	U S Gold		5.52	Road Runner	U S Gold	7.89	11.84				
Defektor	Gremlin	7.89	11.84	Rolling Thunder	U S Gold	7.89	11.84				
Despotik Design	Infogrames	7.89	11.84	Rygar	U S Gold	7.89	11.84				
Dragon's Lair (1 + 2)	Soft Projects	7.07		Saboteur 2	Durell	6.28	9.44				
Driller	Incentive	11.81	14.18	Sapiens	Elite		11.84				
Elite	Firebird	7.86	10.23	Scalextric	Leisure Genius	7.86	11.81				
Elite Collection	Elite	11.81	15.76	Scrabble	Leisure Genius	7.86	11.81				
Enduro Racer	Activision	7.89	11.84	Scrupies	Leisure Genius		11.81				
Epyx on Amstrad	U S Gold	7.89	15.79	Sentinel	Firebird	7.86	11.81				
Evening Star	Hewson	7.07	11.81	September	Activision	7.89	11.84				
Exolon	Hewson	7.07	11.81	Sidearms	Gol	7.89	11.84				
Eye	Prism Leisure	7.86	11.81	Silent Service	Microprose	7.86	11.81				
F A Cup Football 87	Virgin	6.28		Silicon Dreams	Rainbird	11.81	15.76				
F15 Strike Eagle	Microprose	7.86	11.81	Slap Flight	Imagine	7.07	11.81				
Famous Courses Vol 1	U S Gold	3.94	7.89	Solid Gold	U S Gold	7.89	15.79				
Firetrap	Activision	7.89	11.84	Sorcerer Lord	P S S	10.23	14.18				
Firezone	P S S	10.26	14.21	Space Harrier	Elite	7.07	11.81				
Five Games	Beau-Jolly	7.86	11.81	Spitfire 40	Mirrorsoft	7.86	11.02				
Five Games 2	Beau-Jolly	7.86	11.81	Stainway To Hell	Power House	1.57					
Five Games 3	Beau-Jolly	7.86	11.81	Star Games 2	Gremlin	7.89					
Flying Shark	Firebird	7.07	11.81	Star Wars	Domark	7.86	11.81				
Football Director	D&H Games	7.07		Starglider	Rainbird	11.81	15.76				
Footballer of Year	Gremlin	7.86	11.81	Straight Six	Loriciels	7.89	11.84				
Four Smash Hits	Hewson	7.89	11.84	Strike Force Harrier	Mirrorsoft	7.86	11.81				
Freddy Hardest	Ocean	7.07	11.81	Super Hang On	Activision	7.89	11.84				
G Gooch Test Cricket	Audlogenic	7.86	11.81	Super Sprint	Electric Dreams	7.89	11.84				
Galactic Games	Activision	7.89	11.84	Survivors	U S Gold	7.89	11.84				
Game Set & Match	Ocean	10.23	14.18	Suspended	Infocom		19.74				
Gameover	Imagine	7.07	11.81	Sword & Sorcery	P S S	7.86	11.81				
Gary Lineakers Soccer	Gremlin	7.89	11.84	Target Renegade	Ocean	7.07	11.81				
Gauntlet	U S Gold	7.89	11.84	Ten Great Games	Gremlin	7.89					
Gauntlet II	U S Gold	7.89	11.84	Ten Great Games II	Gremlin	7.89					
				Terramex	Grandslam	7.07	11.02				
				Tetris	Mirrorsoft	7.10	10.26				
				Theatre Europe	P S S	7.86					

## CPC6128 utility software

Advanced Art Studio	Rainbird	19.71
Advanced Music System (+484)	Rainbird	23.66
AMX Stop Press	A.M.S.	43.99
Stop Press + Mouse	A.M.S.	70.00
Dbase II	1st Software	78.96
Extra Extra (Stop Press)	A.M.S.	19.74
Mastercalc 128	Campbell	26.07
Masterfile 2 (484)	Campbell	26.07
Masterfile 3	Campbell	31.56
OCP Art Studio	Rainbird	15.78

## Arnor CPC Software

	cass	disc	rom
Protext	19.95	26.95	39.95
Prospell		24.95	34.95
Promerge		24.95	
Promerge Plus			34.95
Utopia			29.95
Maxam	19.95	26.95	39.95
BCPL		24.95	29.95
Model Universe	15.95	19.95	
ROMBO Rom box			34.95
Protext Filer		24.95	
Protext Office		34.95	

Amster's Cage ROM - Viewdata software £31.95

## Arnor PCW/CPC 6128

Protext (v2.2)	59.95
Prowort (German Protext)	59.95
Prospell (v4.1)	29.95
Pocket Protext	29.95
German dictionary for Protext	19.95
Maxam II	49.95
C	49.95
Maxam II & C together	69.95
BCPL	24.95
Protext Filer	24.95
Protext Office	34.95

## Arnor PC software

Protext (v3.1)	59.95
Protext demo disc	7.00
Protext Filer	24.95
Protext Office	34.95
German dictionary for Protext	19.95

**New Release ... £79.95**  
**PROTEXT for the Atari ST**

All prices include VAT, post + packing. Please phone to enquire about products not listed. We can supply software for most computers at very low prices. Please make cheques payable to Arnor Ltd. or quote Access/Visa number. 24 hour sales line on **0733 239011**. Arnor Ltd (AA7), Protext House, Wainman Road, Peterborough, PE2 0BU.

Please send me the following:

Qty	Product	Price (£)

Name \_\_\_\_\_  
Address \_\_\_\_\_



I enclose cheque/postal order for £ \_\_\_\_\_, or please debit my Access/Visa card, number \_\_\_\_\_ exp \_\_\_\_\_/\_\_\_\_\_

Arnor (AA7), Protext House, Wainman Rd, Peterborough PE2 0BU

# REACTION

## ● Fanatics' pudding

I have been considering whether to trade in my CPC 464 for a PCW 9512, but I don't think I will. *Brunword* is what I am using and the facility of having six different screen colour combinations, allowing good vision at all levels and colours of ambient lighting, is a bonus which I shall not lightly sacrifice. In addition, the single function key stroking has got to be a damn sight better than scrolling up and down those *Locoscript* menus.

When I spotted your journal on the news stand, I thought it must be yet another games fanatic's pudding. Although not entirely wide of the mark, I am impressed by your general standard of layout and text presentation. The listings are quite a departure from what one has come to expect, even in expensive computer text books. *AA* looks inviting to read even though a lot of it is irrelevant to my own needs. Nevertheless, I think I shall stay with it for a while.

B J Seward  
Bristol

## ● Flights of fancy

I would like to comment on Digital Integration's *ATF* (*Mastergame* Issue 31). I am a flight sim fan and I buy anything to do with aircraft on the games market - and little else.

Complaints first - you can't do loops, or even rolls. I would have thought you could at least do these simple feats (never mind stall turns and corkscrews!). You have no control over rate of turn. More importantly, the terrain-following capability is so that enemy radar cannot detect you. So any interceptors that come your way must be just stumbled on, and no SAM firing would take place (only AAM firings from interceptors). Take the Tornado GR.1 as an example. It flies "nap of the earth" at about 30 feet in wartime, using a sophisticated terrain-following radar and computer, and later TERPROM - which is a British-designed system which shows all

The section where you get your say about *AA*. Libel suits, love letters, letter bombs and all other reactions are dealt with by Bob Wade - so treat him gently. The address to send your letters to is: Reaction, Amstrad Action, 4 Queen Street, Bath BA1 1EJ. Remember we can't reply personally to letters, otherwise we wouldn't have time to produce a magazine each month. Mail-order enquiries or problems should be aimed at our Somerton address. Subscription problems (not order forms) are now handled by Avon Direct Mail. You'll find both addresses on Line-Up.

ground detail from computer memory (therefore negotiating the need for radar, which is a dead giveaway). Okay, so enemy Airborne Early Warning aircraft can detect you, but not if you use a suite of ECM (Electronic Counter-Measures) like HADES on the Harrier GR.5. Even the plane depicted under the *ATF* logo is the RF-19, or what it will roughly look like, and not the YF-22/YF-23, which are the two aircraft competing for the *ATF* contract. One of these is depicted on the title screen. How inconsistent.

I have been a fan of DI's games ever since *Fighter Pilot*. I still play most of them regularly, particularly *Fighter Pilot* and *Tomahawk*. I bought *ATF* on disk,

and dishing out £14 for a good game but not a very realistic one, which one would hardly expect of DI, is a bit off. When I heard about *ATF* I thought "Great, a simulation that could be exciting because of the ultra high-performance of such a machine," and what do we get? Let's hope *F-16 Combat Pilot* will deliver the goods. Having said all that, it is a good game. What it lacks in realism it makes up for in speed and action. The ASRAAM (Advanced Short-Range Air Missile) is just that: an air to air missile, not an air to ground missile. After *Acrojet*, however, it just seemed a let down.

Mark Paterson  
Holbrook



"WELL - YOU DID PUT IT INTO TWO-COLUMN PRINT MODE ..."

## ● Who's cheating who?

Reaction seems to be a most appropriate name for your letters column. I greatly enjoy reading the letters that your readers send in. Sometimes it is their reaction that fascinates me, and sometimes it is my own. However I really find it difficult to believe that you have actually invited comment from your readers on whether they approve of tape-to-disk transfer.

I can only speak for myself when I say that I have never stolen a programme in my puff (?! - ed). As an adventurer I like to have tape based adventures transferred to disk because they are invariably only produced on tape. If I spent extra money on a disk machine, why must I hunch over a wheezing, grinding cassette machine while it laboriously scratches out its message to memory? It's even worse at the budget game end, with companies taking extravagant measures to ensure that their penny masterworks never load in less than 8 minutes.

I am writing this letter using *Protect*. This comes very heavily protected so that the buyer must constantly use the master disk rather than make a copy. I ask you! *Protect!* What use is a pirate copy of *Protect*? It's fiendishly complicated even with the manual and the thought of attempting to work without it seems to me an extraordinary dedication to the cause of piracy.

I do not believe that I am a hardened criminal, yet I copy programs from tape to disk and from disk to disk. I copy my own programs and I copy those that I have bought, and will contest hotly with anyone that sidles up to me and attempts to imply that I have infringed his intellectual copyright by doing so.

To be honest, I am absolutely sick to the back teeth of hearing the high moral tone in the voices of the software industry as their spokespersons assure us that we (the public) are a motley collection of pirates who are strangling the creative art of the programmer. Could it be that these same per-

sons of high moral tone are judging others by their own standards? How many of them are paying royalties to the composers whose music they are ripping off in the titles and during the game play? Did the companies that produced Gauntlet clones pay US Gold royalties for that idea? Yet these are the same people who are so keen to impress upon us our moral laxity.

Perhaps you could ease my tight lipped ire by explaining precisely what is meant by the word "piracy" and providing an estimate of what is lost to the poor beleaguered software industry, so perhaps justifying this odious yuppie paranoia.

In point of fact, any serious injury to the software houses must mainly arise by unscrupulous people deliberately setting out to duplicate their product and then market it at full price in certain outlets, thus making a larger profit due to the absence of the overheads of development. If swapping of programs between friends is to be vilified as piracy then perhaps the programs might be made a little better value for money, so that people cannot bear to part with them.

I cannot accept for one moment the submission that software is underpriced and that a taped programme is not yielding a substantial profit at £10. Music software houses somehow manage to produce cassettes and pay entire orchestras at a unit price of one half that, which will sell to a very much more limited market. Budget software houses are increasingly demonstrating that they can produce (frequently better) programs at one fifth that.

What it really boils down to is this; your primary responsibility is



to your readers. By all means do your best to prevent piracy where it occurs, but it is wholly unreasonable to suggest that Discology is going to make any more of a dent in the side of Firebird's or Ocean's profits than one of Mr Sugar's twin-tape cassette players. If, on the other hand, it forces them to reduce the monetary difference between tape and disk software, can that really be termed a foul deed?

Do you really need to ask your readers if they want never to put a cassette programme on a disk? Do all the other disk users in the whole wide world just live and breathe to hear those little wheels in the tape machine go round? Surely not!

**Bob McIntyre**  
Aberdeenshire

## ● Search for a star

Last year I used to be seriously interested in astronomy. I owned an Acorn Electron, on which I ran a Starfinder program which would graphically represent the night sky as viewed from any position in the world, at any compass direction. Brief information was stored about the main stars, and could be retrieved by positioning cross-hairs over the star.

Since switching over to Amstrad, and now owning a 6128, my interest in Astronomy has been re-kindled. Do you know of any similar programs that are available for the Amstrad?

I have also acquired a Cumana five and a quarter inch disk drive since then, and I would like to use it as a second disk-drive. Would it be possible to interface the two? If so do you know of any interface I could use, and how much it would be? I phoned up Cumana and they said it would be possible to connect the two if the Amstrad uses an SA400 disk interface if that helps!

**GR Gillham**  
Worle

*As far as I know there's no such program for the CPC, but I'll just bet there's someone who knows different.*

*As for the disk drive, over to Tech Ed, Pat McDonald...*

*You don't even need an interface or software if you have a 40 track single sided drive that works to the Shugart standard. Try KDS Electronics on 04853 2976. They produce an 80 track 5.25 plus software for use as a second drive, and a simple connecting lead for £11.50 inclusive, for those*

## ● Soothe the savage beast

Since computers have been around many, many uses of them have arisen - games, music, education, art, programming languages etc. I think the two that haven't really been used to their full ability are music and art. You complain about games and education fairly often, but as we have seen the games are getting better - think of *Driller*, *Cybernoid*, *Elite* etc. Music and art, although brilliant programs exist, have still not been used to their full potential.

For example, nearly all (if not all) music programs are written so that people can write their own music. Many people don't have the time or patience to do this, but would love to hear music on their computers. Software houses could easily program music to come out of the computer as an excellent performance for a cheap price. They could even do chart records and have graphics to compliment the music. If brilliant games can be programmed then surely music and graphics can. Albums can be



sold on disks and tapes.

Those are only a few ideas but I think they are good ideas and I am sure there could be many more. Why doesn't AA release a gallery of work from its readers, or a collection of music on tape or disk? The CPC can show excellent graphics and its sound chip isn't that bad.

I am sure that many people would buy galleries or albums. Groups have only just started to have all their music published as score, why can't this be another form of media.

**Stephen Parkinson**  
Stoke Newington

*like yourself who already have the necessary hardware.*

*Bear in mind that if you use a simple lead plus suitable drive then the CPC will treat it just as if it were a standard 3 inch second drive so you won't get any real benefits like greater capacity.*

*Looks like there is scope for an article here...*

## ● Scotland the lonely

The majority, all I think, of Amstrad computer shows have been in England, well the far south anyway. I have no objection to this but surely it is possible to have one in, say, Edinburgh? If it was I would take the trip down without fail.

**Andrew Duff**  
Ross-shire

## ● Putting the bulletin

What a lather poor old Philip Davis is getting himself into trying to set up his own BB (Reaction issue 33). He also seems to be very confused. He starts off his letter by stating that he wanted to connect a PC1512 to a remote PPC640 (what's he doing writing to a CPC

mag for?) Then he ends up slagging off the CPC comms market after having a go at the modem manufacturers.

Well let me put the record straight. The comms scene for the CPC has never looked so good. After a long time waiting the CPC is one of the best catered for machines around.

First off, if he wants a modem to auto-answer and run his BB he need look no further than the Pace Linnet. I can heartily recommend it because I use one too.

Secondly, BB Software for the CPC is abundant. (See comms page for more on this - ed) And who says that Comms users aren't a friendly bunch? Philip Davis? Well, I half suspect that by the tone of his letter to AA he has succeeded in rubbing a large number of Sysops up the wrong way. I have been using Comms for the last 2.5 years and have yet to find an unfriendly Sysop. They can't afford to be like that. If they don't get on with people they don't get the punters phoning in. It sounds more like a case of "sour grapes" to me.

With regards to "getting past the main menu". All public Systems allow limited access on the first call, otherwise people



would never phone back again. Most systems offer facilities above and beyond the call of duty and these extra features (PD libraries, mailboxes, multiple phone-lines, gateways etc) have to be funded somehow. The logical answer is that regular users are required to subscribe for the extra services available. Surely that's not an unreasonable condition?

Steve Williams  
WACCI

Steve and all the other comms users will be delighted to hear that from this month there will be a regular comms page. Parts of Steve's letter, and other correspondence on Bulletin Boards prompted by Phillip Davis' letter, have been re-routed in that direction

### ● Here's one I made earlier

I was glad when I saw an Amstrad 6128 on Tomorrow's World, especially when it was used for an experiment about a different way of proving your identity using a machine which shows up the positioning of your veins. It was shown at 8.00, BBC1, 21 April. A disaster struck the experiment went wrong and nothing was said about why. Please tell me if it is the fault of the Amstrad or the BBC.

Tom Whelan  
Croydon

I don't think you need worry about your CPC. I think any failure of the experiment will be due to the fact that it was a complicated one and performed on live TV. You'll have to contact the BBC if you want to know exactly what happened.

### ● Tape trouble

Is it any wonder that people get tape loading problems, when they are encouraged to leave the tape in the datacorder, with the play button still firmly depressed. Meanwhile continuing with the game, oblivious of the permanent damage being made by a probably magnetised tape head and a biting pinch roller to their latest piece of software. There on the front of AA 32, can be seen a CPC drowned in books and coke, with an absent minded professor at play... so is the datacorder. It's not a good idea to festoon the monitor with cassettes, either.

If tapes are cared for, tape heads kept clean (I use carbon tetrachloride on a cotton wool bud

for heads and rollers) and the heads de-magnetised regularly, load errors are kept to an absolute minimum.

Raymond Forward  
Penzance

*Slapped wrist time. You're right of course, we don't want anyone getting into bad habits, do we? Does this mean people are going to be trying to jam telephones into their monitors, as shown on the last issue?*

### ● Know your rights

Yes, it would be easy for S A Warner to put a copyright message within the program - and it would be just as easy for me to remove it or replace it with my own if I wanted to pinch his program. And how could anyone prove it?

A better idea is to find a friendly banker, solicitor, accountant, doctor, vicar, (anyone with professional standing in the community who is NOT a relative) who would be both willing to hold a package for you and to swear, should it ever become necessary, the date when they received the package and that it has not been opened while in their possession.

Having arranged this in advance, you send them a Recorded Delivery package containing: copy of your program, recorded both sides of disk or cassette, a note of what the program does, when you started work on it and any further work you plan. Your friendly holder should write the date he receives the package actually on it and then put it away, unopened.

If you do this before you give copies to friends or software houses, you should be able to prove your copyright if someone tries to rip you off. I would stress that you should only use this method for programs you feel are commercially viable - our friendly holders don't have unlimited storage space for unsaleable magazine listings.

Dorene Cox  
Dagenham

### ● No-one expects...

I have owned a CPC464, for a few months but I have only ever played games on it. Now I would like to put it to better use.

Could you please recommend the best packages and their prices (for the beginner in these fields) for the following:

1. Art and design
2. Music
3. An accounts package

The only problem is I own a 464 and most of these are supplied on disk for the 6128. Which brings me on to my next point. In issue 30, you showed how to turn a 464 into a 6128, but I don't fancy doing it in case I mess it up. Do you know anyone or anywhere I could get it done properly? Also what is the percentage of 128K disk games that would run on the expanded 464 (as I have heard that many software titles

good!

These software pirates are making games better because the prices are going up, and if a game doesn't cost loadsamoney, it must be rubbish!

When are the games for the 16 bit Amstrad coming out? Because I went and bought one off my mate Alan for loadsamoney!

Loadsamoney  
London

Here at AA we've got \*\*\*\*\* all money, but we're THAT 'ard!



don't) And would my tape (multi-load) version of *Renegade* load in one go or would it still load in the different stages?

Lastly, where am I likely to be able to purchase a cheap, second-hand disk drive and printer from?

Paul Kerslake  
Chelsea

*The first part of the question should be answered by this month's Buyer Guide. If you get hold of the parts then any computer or electrical repair shop ought to be able to do the conversion. All 6128 software runs on the converted machine if you have the extra bank of memory. If you've got a 464 with the extra bank of memory then there are products that won't run, but multi-load games may well be able to use it. For second-hand stuff I suggest you look at our classified ads page, or place one yourself.*

### ● Bosh, bosh, shzum, shzum, wallop

Oy! You! Shut your mouth and read this letter! I'm here to complain about the price of games. They're too cheap! They should cost loadsamoney! What do these Mastertronic and Codemasters blokes think they're doing? The Atari ST ain't doing too badly with *Flight Simulator 2* (£49.95) That must be

### ● Pokes for disks

Over the past few months there have been two particular items of interest in Cheat Mode - one being the facility to design courses on *Leaderboard* and the other to do the same thing with *XOR*. I believe both of these were by the same person. My children have both of these games but only on disk, and therefore cannot actually use the cheats because they pertain to cassette. Can anyone supply a disk based equivalent for them?

Barry Scott  
Guildford

### ● Shurely shome mishtake?

Please could you tell me why the man on the front cover of the May issue is holding the joystick wrong? He is holding a right-handed Konix in a left-handed fashion.

AJ Gush  
Lydney

*Ooops! Caught out again. The gentleman in question is none other than Alec Rae from our sister magazine 8000 Plus. We forgot he was left-handed when we were taking the shot - hence the wrong way round joystick. It's understandable anyway, because PCW owners get so few games to play they probably haven't seen a joystick before.*

# Helpline

Where eager Amstrad experts volunteer aid to fellow readers having problems

If you too feel helpful, just send us your name, address, phone number (say so if you don't want it to be printed) and subject on which you want to help. Please write on a postcard or the back of a stuck-down envelope to simplify administration here in the office. Send to: **Helpline, Amstrad Action, 4 Queen Street, Bath, BA1 1EJ.** If you are asking for help, make direct contact with the appropriate Helpliner - don't pester your usually-patient (but pressed) editor. By post, you must include a self-addressed, stamped envelope for the reply - otherwise you won't get one. And if you telephone, stick to socially acceptable hours!

Reminders: Anyone involved in piracy is not welcome on this page and if problems arise they will be removed. Keep it legal, it's in everyone's interest. A plea to helpliners - if you do receive SAE's from people, please return them with some acknowledgement. Lastly a reminder that if you want to come off the Helpline you should write and say so.

The game lists are getting much too long again. Keep them to four lines of text, in addition to your name and address. Otherwise we'll cut it ourselves or abbreviate it to "loadsagames".

Free disk recovery. Send disk with erased file(s) and 50p for quick return.

**Mick Hopewell, 55 Hawthorn Crescent, Arnold, Notts NG5 8BE**

Multiface II, Citizen 120D TV tuner, Who Dares Wins II, Ikari Warriors, Prohibition, Ace, Renegade, Combat School.

**David Örn Heidberg, Brunaland 18, 108 Reykjavik, Iceland**

Tips and some pokes for: loadsagames.

**Vinod Patel, 47 Balmoral Rd, Willesden Green, London NW2 5BN**

Basic programming, Logo, CPM+ and 2.2, Cherry Paint, Discology, Ultrasound, Quill, Illustrator, DTP and fanzine writing, Tasword 464 and 6128, debugging, adventure writing, disk drive problems, WIMP environment programming.

**James Woodman, 6 West End, Long Whatton, Leics LE12 5DW**

Listings - 8p a page. Send tape or disk + SAE.

**AJ Davies, 43 Tan Hill Dr, Beaumont, Lancaster, Lancs LA1 2JB**

Advice on: external control/data acquisition (light, sound, heat, water, brainwaves etc), Midi, sideways Ram, advanced sound ICs on CPC (CBM 6581-SID etc), CPC oscilloscope, interfacing, NMI's, RSX etc

**Raphael Baker, 48A Hill St, Hilperton, Wilts BA14 7RY = 02214 63492**

All aspects of Basic especially adventures, debugging and compression, simple machine code including RSXs and interrupts, playtesting, poking, digitiser type-in. Please state level of understanding.

**Sean McManus, 226 Chertsey Rise, Stevenage, Herts SG2 9JQ**

Tips on: Terror of the Deep, Hyperbowl, Nemesis, Mission Omega, Ikari Warriors, Academy, Hardball, Wizard's Lair, Koronis Rift, Mercenary II, Enduro Racer, GP Sim.

**Chris Stephens-Gaylon, 25 Rhodesia House, Princess Elizabeth Way, Cheltenham G151 7PJ**

Pokes for Combat School, Gryzor, Gauntlet 2, Space Harrier, 1942, Alien Highway, Rambo, Super Hang-On, He-Man, Driller, Commando, Duct. Tips for Bobsleigh, Driller, Red LED and GP Sim. SAE for pokes.

**Wingchee Man, 9 Mill Rd, Aveley, Essex RM15 4SJ = 0708 862349 after 5pm, except Fridays**

GAC, Basic, Type-Ins, Pokes, Spindizzy, Knight Tyme, Bombjack II, JSW, Yie Ar Kung Fu, Manic Miner.

**Brian Power, Radharc-na-mara, Westown, Tramore, Co Waterford, Eire.**

Tips, pokes etc for: 1942, Spindizzy, Lightforce, Dan Dare, Thrust, Xevious, Space Harrier, Leaderboard, Ikari Warriors, Ghosts'n'Goblins, Monty on the Run.

**Anthony Croxford, 71 St Marys Rd, Huyton Village, Merseyside L36 5SR**

Loadsagames.

**Matt Grimshaw, 35 Nursery Avenue, Bexleyheath, Kent DA7 4JX**

Advanced Art Studio, Cherry Paint, Tasword, 6128 Bank Manager, dk'tronics speech, DMP 2000, Basic, CPM+, Guild of Thieves, Mercenary, Starglider.

**David Carter, Ruxley House, 28 Mt Hermon Rd, Woking, Surrey GU22 7UH**

Basic - especially graphics, machine code programming - especially firmware and ROMs, sprites, Maxam, DMP 2000, debug listings - send SAE, Help with lots of games. Making Quickshot II and Turbo CPC compatible.

**Thomas Jolly, 5 Trinity Terrace, Corbridge, Northumberland NE45 5HW = 043471 2804 after 4pm on weekdays.**

Basic writing, testing and debugging, machine code, assemblers, firmware, converting games to disk, finding and changing messages in games, deprotecting Basic, RSXs, Melbourne Draw, Image System, games and adventures.

**Alex Jeffreys, 21G Powis Square, London W11 2AZ**

Pokes, calls, outs and RSX commands. Program and data protection. Queries on Basic, Forth, CPM and MS-DOS. Some machine code. Tips on Driller. Adventure writing and programming.

**Sean Holyoak, 10 Shoreham Road, St Pauls Cray, Orpington, Kent BR5 2QZ**

Driller, Game Over, Rogue Trooper.

**MS Cornwall, 8 Prestwick Ave, Felixstowe, Suffolk IP11 9LF = Felixstowe 286026**

Antirad, Sorcery, Green Beret, Ghosts'n'Goblins, Ikari Warriors, Airwolf, 5AXE, Ping Pong.

**Francisco de Sousa, Avenida D.Afonso Henriques, 17 1Dto, 2870 Montijo, Portugal**

Solving bugs in Basic and most machine code programs. Enclose listing + description of program + description of problem) If possible enclose cassette with program on 464 only. If machine code enclose assembler listing.

**Paul Jones, 78 Fitzwilliam Street, Swinton, Rotherham, S.Yorkshire, S64 8RW**

Converting programs for the Vortex disk drive. Simple machine code. Hacking. CP/M programs & utilities. A whole bunch of public domain programs.

**Mark de Bont, de Foes 15, 5581 AP, Waalre, Holland, = (04904) 13963**

Radzone, Ghosts and Goblins, Knight Tyme, Dragons Lair, Green Beret, Gauntlet, Feud, Starquake (codes), Boulder, Boggit.

**David Brooke, 8 Birkby Grove, Bilton Grange, Hull, HU9 4PZ**

Knight Tyme, Spellbound, machine code, Basic, Word Perfect, Melbourne Draw, GAC, pokes, maps, hacking, DMP 2000 problems, games development using GAC, word-processing, graphics (screen dumps), all CPC games. Can also print program listings for a 40p postal order. How to do pokes and problems using modems. (I have a Voyager 7)

**Guy Sicka, 78 Chesterfield Road, High Barnet, Herts, EN5 2RF = (01) 441 5612**

Basic programming, some machine code.

**Paul Bower, Elm Gable, Hermitage, Newbury, Berks. RG16 9SA = (0635) 200891**

Tasword 6128/Tas-spell 464 & 6128, Tasprint, Tascopy, Basic programming, Masterfile III, Locksmith+, Masterdisc, Epson LX printers, CPM and help on then game Elite.

**Oystein Kjaereng, Torvymrv.42, 3170 Sem, Norway**

Feud, BMX Simulator, Equinox, Who Dares Wins 2, Frank Bruno's Boxing, Shogun, Paperboy, Terminus, Jailbreak, Curse of Sherwood, Nemesis, Ghostbusters, Willow Pattern, Amaurote, Spellbound.

**Sergio Dunkley, 62 Rainbow Drive, Melling, Liverpool, L31 1BZ, Merseyside. = (051) 547 2714**

Basic, machine code, Laser Genius, tape loading, disk loading, firmware, graphics, sound, hints, pokes, mapping, Word Perfect, Sorcery+, Transmat, Oddjob, Warlord, Kung Fu Master, Bruce Lee, Boulder, Gunflight, Pip, will print listings for 20p

**Steven Lawson, Plot 77, Meir Park, Staffordshire, ST1 6HQ.**

Basic programming, machine code programming, firmware calls, Amsdos calls + accessing them, adding second drives (3in + 5.25in), tape loading problems, multiface two, printer problems.

**Kevin Bryant, Jessamine Cottage, Chapel Lane, Ashford Hill, Newbury, Berks, RG15 8BE. = Tadley 71792**

GAC adventure writing and problems. Also conversions to other formats undertaken for published GAC authors by fellow established author.

**C.Sharp, 4 Osprey Gdns, Sheffield, S2 5GE, S.Yorks**

Loadsagames.

**Paul Crich, 33 Hills Road, Strathaven, Lanarkshire, ML10 6LQ. = (0357) 29606**

Loadsagames.

**David Howlett, 53 St Marys Avenue, Alverstoke, Gosport, Hants, PO12 2HU**



# Castle Computers



NOW  
TAKEN



Castle House,  
11 Newcastle Street,  
Burslem,  
Stoke-on-Trent,  
ST6 3QB  
Tel: 0782 575043

## SALE SALE SALE SALE SALE SALE SALE SALE SALE SALE

### AMSTRAD CLEARANCE

Armageddon Man	5.95
Amazing Shrinking Man	1.99
Auf Wiedersehen Monty	2.75
Agent Orange	1.99
Avenger	1.50
Aliens US	2.99
Aliens UK	1.99
Arnhem	3.95
Basket Master	3.95
Bride of Frankenstein	1.99
The Big Sneeze	1.99
Bubbler	0.99
Battle of Britain	3.95
Battle for Midway	3.95
Big Trouble in Little China	2.99
Bridge	2.99
GFL Baseball	2.99
Bobsleigh	3.95
Ballblazer	1.99
Basil Gt Mouse Detective	2.99
Combat School	3.95
Convoy Raider	2.99
Challenge of Gobots	1.99
Cholo	2.99
Centurions	1.99
Contamination	1.50
Crysllicker	1.50
Cosmic Shock Absorber	0.99
Dan Dare	1.70
Doomsday Blues	1.50
Dambusters	1.70
Deathsville	1.50
Doomdark Revenge	2.99
Elite	7.50
Eye	2.99
Equinox	1.75
Escape Singes Castle	1.99
Elevator Action	1.50
GFL Football	2.99
Four Smash Hits	6.99
Fairlight	1.99
Future Knight	1.70
Fighting Warrior	0.99
Frankie Goes to Hollywood	1.75
Gladiator	1.99
Greyfall	1.50
Grangehill	1.99
Glider Rider	1.70
Guadal Canal	2.99
Gryzor	3.95
Gyroscope	0.99
Galactic Games	2.99
Gauntlet	2.99
Gauntlet II	4.95
Hot Runestone	1.50
Hijack	1.50
Heatland	1.99
Hacker II	1.75
Highlander	1.99
High Frontier	2.99
Hydrofool	2.50
Hive	0.99
Inheritance	1.99
Impossaball	1.75
Impossible Mission	1.70
Into Eagles Nest	1.99
International Karate	2.50
Jackal	2.99
Killed Until Dead	2.99
Kidsplay	3.95
Kinetic	1.50
Lazer Tag	4.95
Lord of the Rings	3.95
Leviathan	1.99
Mutants	1.99

Mordons Quest	1.99
Mag Max	2.99
Monopoly	4.95
Metrocross	1.50
Movie	1.50
Mystery of Arkham Manor	2.99
Mystery of the Nile	1.99
Matchday 2	5.50
Marble Madness	1.99
Nigel Mansels G. Prix	7.25
Nomad	1.25
Nodes of Yesod	1.99
Nexor	1.50
Nemesis Final Challenge	2.99
Out of This World	1.25
Outrun	4.95
Preditor	6.50
Pulsator	1.25
Quartet	2.99
The Quill	3.95
Ramparts	2.99
Red Scorpion	1.99
Rocky Horror Show	1.99
Road Runner	3.95
Red LED	2.99
Revolution	0.99
Renegade	3.95
Slaine	2.99
Saboteur 2	2.25
Sorcerer Lord	7.95
Slapfight	2.99
Sigma 7	1.99
Starstrike II	1.99
Shadow Skimmer	2.99
Spy v Spy: Arctic Antics	1.99
Survivor	2.99
Shockway Rider	1.50
Stainless Steel	1.50
Short Circuit	1.99
Sidney Affair	1.99
Strike	0.99
Shadows of Mordor	2.99
Supersprint	2.99
Starglider	6.95
Shaolins Road	1.75
Shard of Inovar	0.99
Samurai Trilogy	2.99
Trap Door	1.70
Through the Trap Door	2.99
10th Frame	1.50
Theatre Europe	3.95
Thing Bounces Back	2.99
Tai Pan	2.99
Tarzan	1.50
Throne of Fire	2.99
Never Ending Story	2.99
Thundercats	6.25
Vixen	6.75
'V' All Out Attack	0.99
Thanatos	1.99
World Games	3.95
Warlock	1.75
Xevious	0.99
The Young ones	1.99
Xor Games Designer	3.95
Yes Prime Minister	2.99
Yogi Bear	1.99
Yie Ar Kung Fu	1.99
Popeye	1.70
Strike Force Cobra	1.70

### AMSTRAD CASSETTE COMPILATIONS

**TEN GREAT GAMES**  
Avenger, Future Knight, Krakout,  
Boulder, Footballer of the Year,  
Trailblazer, Highway Encounter, Monty  
on the Run, West Bank, Jack the Nipper  
**ALL FOR £5.95**

**TEN GREAT GAMES VOL 2**  
Auf Wiedersehen Monty, Samurai Trilogy,  
Convoy Raider, Jack the Nipper II, Basil  
Mouse Detective, Death Wish 3, Mask,  
The Duct, Thing Bounces Back,  
The Final Matrix  
**ALL FOR £6.95**

**WE ARE THE CHAMPIONS**  
Super Sprint, Renegade, Rampage,  
Inter Karate +, Barbarian  
**5 TOP GAMES £6.95**

**ARCADE FORCE 4**  
Indiana Jones & Temple of Doom,  
Metrocross, Road Runner,  
Deeper Dungeons  
**NOW ONLY £6.99**

**COIN OP CONNECTION**  
Breakthru, Crystal castles,  
Express Raider, Metrocross  
**BE QUICK AT ONLY £2.99**

**4 SMASH HITS**  
Zynaps, Exelon, Rana Rama, Uridium +  
**NOW ONLY £6.95**

**KIDSPRAY**  
Xeno, Grumpy Gumphrey Supersleuth,  
Knightshade, B. McGuigan's Boxing,  
Starstrike, Starion, Monty on Run, Thing  
on a Spring, Marsport, Night Gunner  
**ALL 10 FOR ONLY £3.95**

**PACK OF ACES**  
Inter Karate, Boulderdash, Nexus, Who  
Dares Wins II  
**AT ONLY £3.95**

**PRESTIGE COLLECTION**  
Rescue on Fractalus, The Eidolon,  
Koronis Rift, Ballblazer  
**MEGA COMPILATION AT  
£3.95**

**MAG 7**  
Wizball, Short Circuit, Arkanoid, Head  
Over Heels, Cobra, The Great Escape,  
Frankie Goes to Hollywood,  
Yie Ar Kung Fu  
**8 OCEAN GAMES FOR £6.99**

**TARGET RENEGADE**  
**IN STOCK AT £6.50**

### AMSTRAD DISC

Frankenstein	3.95
Slap Fight	3.95
Through the Trapdoor	3.95
Design Design	2.99
Sorcerer Lord	8.95
Little Comp People	4.95
Shockway Rider	2.99
Electraglide	2.99

• We're selling many games as  
• blank discs. These discs are  
• not second hand, but are sold  
• as blank  
• **10 DISKS FOR £18.00**  
• **P&P FREE**

Cosmic Shock Absorber	2.99
Prohibition	3.95
Mutants	2.99
Hydrofool	2.99
Big Trouble in Little China	3.95
Leviathan	2.99
Airwolf	3.95
Yogi Bear	3.95
Book of the Dead	3.95
Glen Hoddles Soccer	3.95
3D Stunt Rider	2.99
Vera Cruz	2.99
Cobra	3.95

• **HELP! we must clear all of**  
• **our stocks of Amstrad discs**  
• **this month! PHONE NOW,**  
• **They won't last long!**

Druid	2.99
Kinetic	2.99
Warlock	2.99
Catch 23	2.99
Ninja Hampster	3.95
Waterloo	3.95
Mario Brothers	3.95
Cholo (back in stock)	4.95

• **DRUID II ENLIGHTENMENT**  
• **NEW IN AT £4.95**

Nemesis Final Challenge	3.95
Bridge	3.95
Leviathan	3.95
Spellbreaker	9.50
Seastalkers	9.50
Suspect	9.50
Short Circuit	2.99
Werner	2.99
Clever & Smart	2.99
Spy v Spy	3.95
Uchi Mata	2.99
Kung Fu Master	2.99

**PLEASE NOTE!**  
We are clearing all of our  
stocks out before we stock take  
at the end of this month. Grab  
a bargain. Please state an  
alternative as we expect to sell  
out of this stock very quickly.

For this month only we will  
not only match, but beat  
anybody elses price for any  
disc or cassette advertised!

**ALL CASSETTE**

Super Sprint	2.99
Quartet	2.99
Combat School	3.95
Gryzor	3.95
Yogi Bear	1.99
Impossible Mission II	6.50
Monopoly	4.95
World Games	3.95

**REMEMBER!**  
We'll beat anybody's price so  
make that phone call now  
**0782 575043**

# AMSCENE

Monthly update on what's new on the CPC scene

## RAM shortage bytes

In AA32 we carried a story indicating that there would be no price increase for any of the CPCs due to the shortage of DRAM chips. Well, the CPCs may not have been affected but the memory expansions produced by Ram Electronics have been. Price increases have been necessitated and will already be in operation by the time that you read this.

"It really hurt us to have to do this," RAM stated. "But you either have to pump up the price to a profit level or delete the product from the catalogue. We didn't want to do that - these products are some of our best sellers."

"As soon as the situation improves regarding price and availability, which is very important at the moment - there are less DRAMs around, we will do our best to bring the price back down again."

The actual products affected are the CPC464 64K memory expansion, old price £44.95 - now £49.95. The 256K memory expansion for the 464 and 6128 (separate models) used to be £79.95 - now £129.95. The 256K silicon disks have suffered similarly, with a price tag of £149.95, compared to an old price of £99.95. The more memory a product contains, the higher the increase.

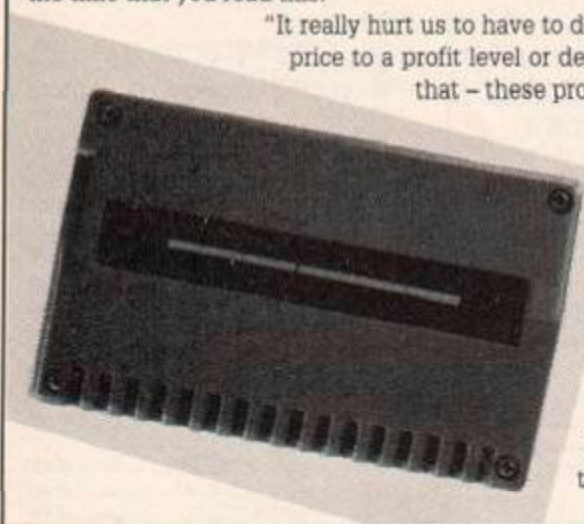

## Games player of the year

The Power House is on the hunt for their games player of the year. All you have to do to enter is send in a photograph of a Power House game screen, with your high score on it. It must reach them by the 10th of October. The highest scorers on each Power House game will be invited to their Wimbledon offices for the grand final in November. Each champion will receive 20 free games and the supreme champion will get 30 games and a Sony personal stereo.

To enter, send your screen shot to: Andy Blazdell, The Power House, 204 Worple Road, Wimbledon, London SW20 8PN.

## Multi-format tapes and disks

Mandarin software have announced the launch of a triple format disk for the CPC, PCW and Spectrum +3. The same program is provided for all three machines on a single disk. The first product to be released will be *Time and Magik*, a compilation of the three adventures: *Lords of Time*, *Red Moon* and *The Price of Magik*.

On the disk there are three driver programs, one for each machine, and the main program. The B side of the disk has all of the location pictures in compressed form. The drivers contain the machine specific code which includes: keyboard scanning, disk file handling and screen handling. All you have to do to play it on your machine is run the appropriate driver. The advantage to the distributor is that now they only have to stock one version of the game rather than three.

While on the subject of multi-format releases, Mastertronic have just released their first few titles that come with a Spectrum game on one side and an Amstrad one on the other. The first titles to arrive are *On Cue* (reviewed this month), *FA Cup Football*, *Impossible Mission* and *Droids*. *FA Cup Football* is a re-release of the old Virgin game. *Impossible Mission* is the predecessor of last's months Rave game *Impossible Mission II* and *Droids* is a game loosely based on the cartoon series that stars the two heroic robots, R2-D2 and C-3PO.

*On Cue* and *Droids* cost £2.99 each, *FA Cup Football* and *Impossible Mission* cost £1.99 each on cassette.



## Star's 24-pin printer

Star Micronics has just launched the Multifont LC24-10 24-pin printer for £379. Eight fonts are built in the printer: Courier, Prestige, Orator, Script and the italic equivalents. Extra fonts can also be added using plug in cards. The text can be altered to be shadow, outline or both. The print pitch can be switched between pica, elite, condensed and proportional spacing.

Forward and reverse micro-feed, self test and hex dump facilities are also available. The print rate is 170 characters per second in draft mode and 57 cps in true letter quality mode. The maximum carriage width is 10 inches. A 7K buffer is built into the LC24-10 and the facility to insert a 32K Ram card with battery back-up is available. (*That's enough statistics - ed.*)

For further information contact Star on: ☎01 840 1800 or write to them at: Star Micronics UK Ltd, Craven House, 40 Uxbridge Road, Ealing, London W5 2BS

## Elite's encore

Elite are the latest software house to enter the budget market with their new label Encore. The label is going to be used to re-issue Elite's old full price titles.

Elite have an extensive back catalogue of titles, the first of which to appear is *Frank Bruno's Boxing*. All the re-releases will be available on cassette only at £1.99. Elite promise that all their full price titles will be of high quality and won't appear on the budget label for three years after their original release.

Other titles lined up for a budget re-release this summer are *Airwolf* in June, *Battleships* and *Saboteur* in July, and *Bombjack* in August.



## Out of print book service

Last month we mentioned the Out of Print Book Service as a possible means of obtaining books that have gone out of print - in this case "Assembly language programming for the Amstrad CPC 464, 664 and 6128" by A&D Stephenson. Since then we've received a little more information on the company. If you want to find a book then write to them at the address below including an SAE. You are not charged when you ask them find a book, but as soon as they've tracked it down they'll contact you. If in the meantime you've found the book then you can just tell them that you're not interested and you still won't be charged. If on the other hand you still want the book then you will be charged for the book at the price quoted. A minimum fee is usually about £5.

The Out of Print Book Service can be contacted at: 17, Fairwater Grove East, Fairwater, Cardiff CF5 2JS or ☎ 0222 569488.

## Doing it on a desktop

Hot off the Heinemann/New-Tech presses is a new book called *The Desktop Publishing Book* by Peter Worlock. Although not aimed at the CPC's specifically it does contain a lot of general information suitable for people questing for knowledge on the subject. It is fully illustrated throughout with black and white pictures.

However, it must be considered that the hole this work will make in your wallet is not exactly what I'd call insubstantial. It costs £12.95 and has an ISBN of 0-434-92369-9.

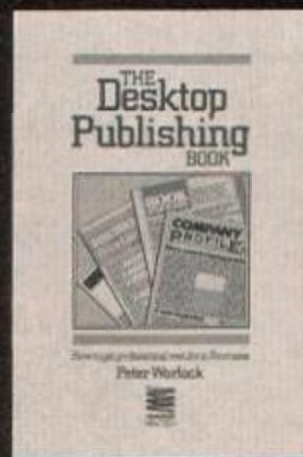

## Budget releases

The Power House have just launched two more titles: *Astroball* and *Metropolis*. *Astroball* is a multi-level game of collect and avoid and *Metropolis* is an exploration game where you have to find fuel for your ship so that you take off again. Both cost £1.99 and are available on cassette only.



The old Rave game *The Eidolon* has just re-appeared in budget form on the Mastertronic Ricochet label. It's a game of exploration and monster bashing as you travel around in your own subconscious mind. It's well worth getting at the new price of £1.99.

*Bruce Lee* is another old title that's just made it onto the Americana budget label. You must penetrate the fortress of the Evil Wizard and defeat him if you are to obtain immortality and wealth. Yet again it's available only on cassette at £1.99.



## Clang, clang II

Palace are at this very moment working on a follow up to *Barbarian* called, surprisingly enough, *Barbarian II - The Dungeon of Drax*. It's a multi-load game with hordes of weird and wonderful monsters to hack your way through. You also get a choice of playing the barbarian or the Princess Mariana in the quest to defeat Drax. Maria Whittaker and Mike Van Wyjk are on the packaging again as the duo out to bash Drax. *Barbarian II* is due to be released in August.



●Bet you can't guess which legs belong to Maria Whittaker, Mike Van Wyjk and programmer Steve Brown

## Flying Finn enters netherworld

*Netherworld* is a new game from Hewson that's been programmed by Charlie T, the Flying Finn. *Netherworld* is a place where the forces of good and evil are locked in eternal conflict. You've become trapped in there and the only way back is through bribery and battle. Diamonds are what you need to escape, unfortunately they're guarded by dragons, acid, fire and monsters. Can you find your way out of this living hell? Watch out for *Netherworld* when it's released in August.

*Heathrow International Air Traffic Controller* is being re-written and re-launched by Hewson to add some more features to the game. The original game dates back to the dark ages before AA. Although nothing is certain yet there will be some more airports added to those that are already in the game: Heathrow and Schiphol will still be there, Frankfurt and Chicago are the favourites for the new airports.

Hewson's new shoot-em-up *Marauder* is due for release on the 28th of June. In it you hurtle around the screen blasting everything in sight. It should be on the streets by the time you read this at £9.99 on tape and £14.99 on disk.

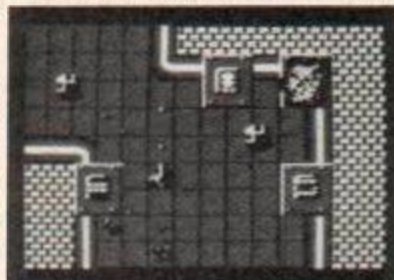

## Lords comes to light

Great news for anyone trying to get hold of a copy of *Lords of Midnight*. In last month's feature on strategy/wargames we said it was no longer available. Much to our delight we have since discovered that a mail-order company, Budgetsoft, has stocks of it on tape at £3.75 plus 75p postage and packaging. If you still want to get this gem of a game you can contact: Budgetsoft, Dept AA, 33 Little Breach, Chichester, W. Sussex, PO19 4TY.

## Not a lot

The computer version of the TV quiz where time is of utmost importance, *Every Second Counts*, has just arrived from Domark on their TV Games label. The TV quiz is for three teams of two, one male and one female. The computer version can be played by one to six people. Previously the TV Games products have only been available on tape, but now it's available on disk too. *Every Second Counts* will cost you £7.95 on cassette and £12.95 on disk.

## Questionnaire results

The five lucky winners of £25 of software from our Questionnaire competition are: Stewart Russell from Glasgow, C Ferré from Havant, RG Tanner from Bargoed, Nicholas Feldman from Walthamstow and Graham Read from Stalham. Congrats to them, we'll be in touch about your prizes.

The results printed are based on 500 questionnaires - a sample that should produce accurate results.

### 1. How old are you?

Under 12 8.4%, 13-16 35.6%, 17-22 11.6%, 23-30 13.8%, 31-40 15.6%, 41-50 8.6%, 51-60 3.6%, over 60 2.8%

### 2. What sex are you?

Male 95.2%, female 4.8%.

### 4. What hardware do you own?

464	48.4%
664	3.0%
6128	49.8%
464 disk drive	14.2%
2nd disk drive	10.4%
Modem	5.6%
Romboard	10.8%
Mem. upgrade	8.4%
Multiface	16.6%
Joystick	87.8%
Ext. speakers	14.0%

Interesting to see that 6128s are now the most prolific machine and that two-thirds of owners have disk based systems.

### 5. How long have you had a CPC?

0-6 months 8.6%, 6-12 months

15.6%, 1-2 years 33.2%, over 2 years 43.2%.

### 6. How much do you spend a month on software and hardware?

£14.66.

### 7. What sort of games software would you buy?

Full-price 47.2%, budget 61.4%, coin-ops 32.0%, adventures 37.4%, wargames 19.4%, simulations 48.4%, shoot-em-ups 33.8%, general arcade 53.8%.

### 8. What sort of serious software would you buy?

Word-processor 55.8%, database 41.6%, spreadsheet 26.4%, art 55.6%, music 32.4%, programming language 25.8%, assembler 25.0%, educational 27.0%, comms 7.8%.

Still lots of interest here in all aspects of serious software.

### 9. Do you own a printer?

Yes 51%. By far the most popular make was the DMP 2000 and Amstrad printers accounted for 33 of the 51%. Of the other 18% the most popular makes were Citizen, Epson, Star and Brother with about 2% each.

### 10. Which accessories do you regularly buy, or are interested in buying?

Blank disks 63.4%, printer paper 33.8%, blank tapes 38.8%, printer ribbon 33.4%, disk box 21.2%, dust cover 28.6%, printer stand

4.2%, copy holder 9.4%.

### 11. What magazines do you regularly buy?

Magazine	% readers	Rating out of 5
AA		4.45
ACE	13.4%	4.08
Games Mach	6.6%	3.70
C&VG	14.4%	3.64
CWTA CPC	34.2%	3.26
ACU	40.3%	2.98
Pop. Weekly	5.4%	2.92

### 12. Where will you buy hardware and software?

High street chain stores 49.0%, mail-order 77.2%, computer shop 58.8%.

### 14. What are the main reasons you buy AA? (We asked you for three sections so the percentages don't add up to 100)

Action Test	41.6%
Type-Ins	37.2%
Cheat Mode	32.6%
Serious Software	22.4%
Hot Tips	18.0%
Reaction	12.4%
Pilgrim	11.2%
Problem Attic	9.0%
Adverts	9.0%
Hardware	8.6%
Buyers Guide	7.6%
Special Offers	7.6%
Words Work	7.0%
Abs Beginners	7.0%
Amscene	6.8%
First Bytes	3.2%
Helpline	3.2%
Bar CPM	2.2%
Rear View	1.6%
Small Ads	1.6%

### 16. How do you receive AA?

Subscription 28.8%, newsagent

order 15.6%, newsagent 55.4%.

### 17. How many other people read your copy of AA?

1.14 people (average).

### 18. What three pieces of software do you use most frequently?

We've added up all the votes to bring you the favourite pieces of software in order.

1. Tasword/Amsword
2. Protexit
3. Mini Office 2
4. Gauntlet 1&2
5. Compilations
- 6= Masterfile
- Matchday 1&2
8. Elite
- 9= Advanced Art Studio
- Driller
- Renegade
- 12= Head over Heels
- Maxam
14. Gryzor
15. Arkanoid
16. Ikari Warriors
- 17=GAC
- Leaderboard
- Vulcan

At this point there are a lot of titles close together, namely: ATF, Boulderdash, CPM, Discology, Infocom games, Image System, Mastercalc, Out Run, Tau Ceti.

Many thanks to all those who replied to the questionnaire - the results will be invaluable in producing the sort of magazine you want. The answers to question 15 "What regular sections or one-off features would you like to see in the future?" have been duly noted and will be paid heed to.

# CAN YOU TACKLE THE HIGHER STRATEGY?

# FOOTBALL MANAGER 2



Kevin Toms, inventor of the world's best selling football game says, **"It beats my best seller - hands down"**



New improved features include:- Spectacular graphics and tactics with unlimited action, more fun and excitement.



The press says **"It's fantastic - another all time great."**



The computer panel says **"We were looking for improvements on Football Manager to be assured of a good game. We were surprised - it's outstanding! It's gold class!"**

CBM 64/128 Cassette	— £9.99
CBM 64/128 Disk	— £14.99
Spectrum Cassette	— £9.99
Spectrum +3 Disk	— £14.99
Amstrad Cassette	— £9.99
Amstrad Disk	— £14.99
Amiga Disk	— £19.99
Atari St Disk	— £19.99
IBM PC Disk	— £19.99

*"Football Manager 2 is not just an improvement on Football Manager - it's the next generation!"*

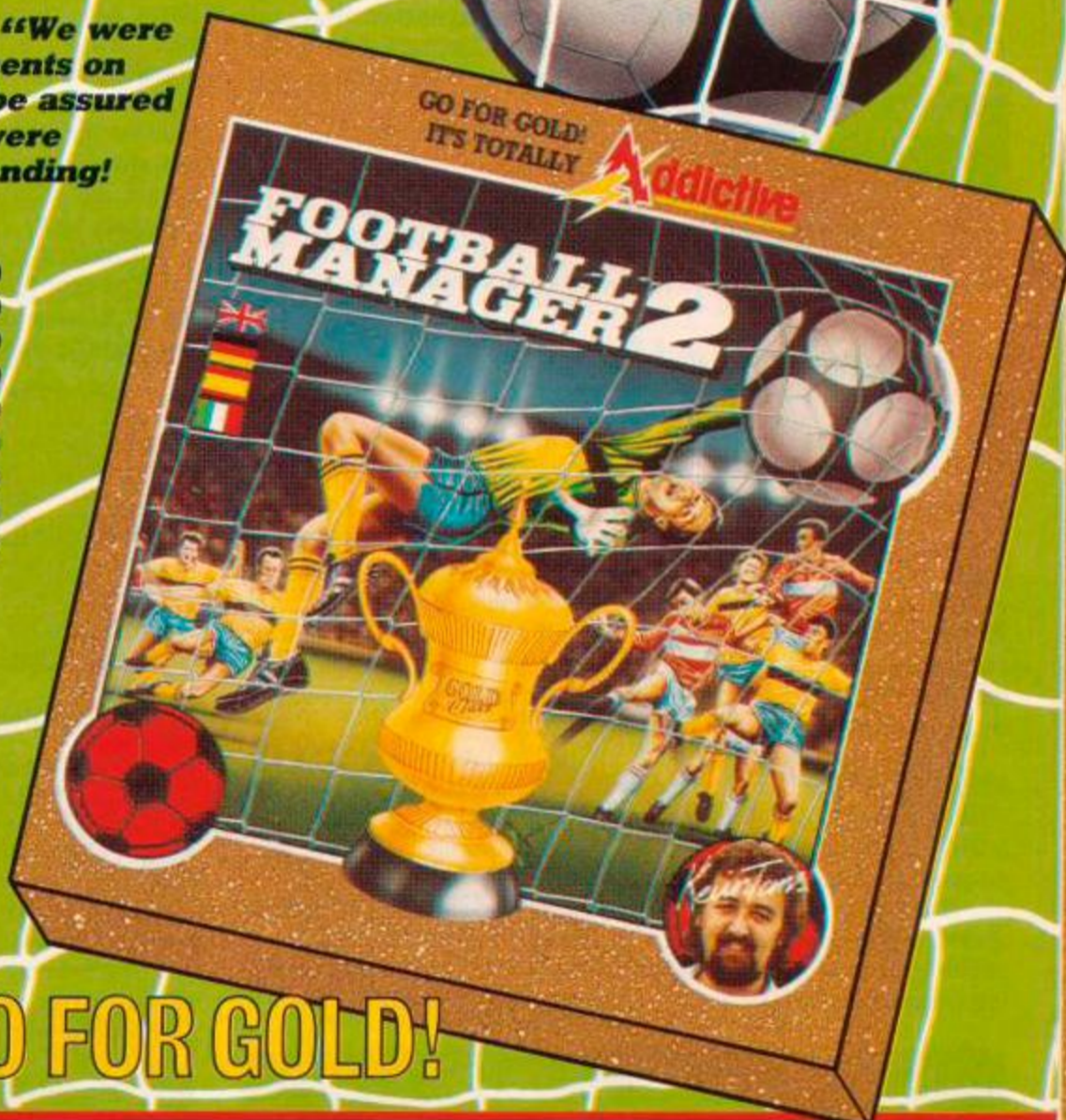

## GO FOR GOLD!

Screen shots from Atari St system.

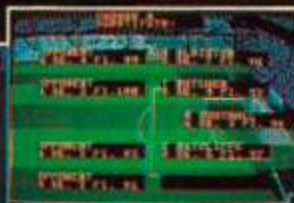
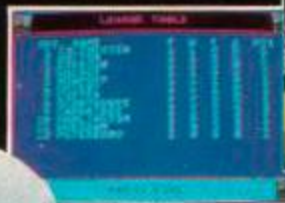

*Kevin Toms.*

IT'S TOTALLY **Addictive**

\*Addictive games is a division of- Prism Leisure Corporation plc, Unit 1, Baird Road, Enfield, Middlesex EN1 15J.

Street Date: All formats June 17th

# Small is beautiful

The CPC isn't usually considered as a competitor in the business sector, but Pat McDonald finds there are many uses for it and lots of people making the most of them.

The first half of this article looks at the latest software available for the small business. There's also a box noting some of the other pieces of software already available. Then we've talked to some of the people that actually use a CPC to help with their business, and they've come up with some revealing information.

## Protext Filer/Protext Office

Arnor, £24.95/£34.95, disk only

When *Protext* was released a couple of years ago, it was widely hailed as the word-processor for the Amstrad. Since then Arnor have been busy updating it and adding extra programs - *Promerge* and *Prospell*. Now it seems they have come up with something a little more novel.

It is fairly obvious that the product is a filing system of some sort, and *Protext* and *Promerge* are necessary to use it. These can either be on disk or ROM. If you use CPM *Protext* then that is good enough in its own right.

### Vive la difference

Occasionally the difference between a database program and a filing program seems pretty thin. The important point to remember is that filing systems store information. This means that what is held on it is understandable in its own right, and no processing or statistical analysis is necessary.

Databases, on the other hand, store data. They can sort through and analyse data in order to produce some further conclusions.

How do you use it? The idea is that all information held in the filing system is input using *Protext*. Both fixed length records and variable length records are supported: this means that your records (file cards, if you like) can share the same layout, or not, according to your taste.

You can set up the fields as well - this means name, house number and road name, town, county etc. You could add others, like age, interests, occupation. You could even base your filing system on a collection, such as stamps, postcards or coins. No problem.

What you have so far is the main file. Two further types of file are utilised by the program. The update file can be added to the main file when you want to add records but don't want to go back to *Protext*. The other - the sort file - is a smaller part of the main file which has been stripped out of the file for a specific purpose.

The option to search through a program and take out specific records is very well implemented. The criteria on which a search is based can be taken from up to three fields, and can use either AND plus OR logical operators. For instance, you could select only those records where a

Mr. Smith lived in Glasgow or Edinburgh. A further example would be to search for everybody who lived in England and Wales.

So, you have certain records taken out of the main file and hived into a sort file. What can you do with them? Already supported are four mail merge templates, and you can add your own quite easily. These can be used either to print address labels or included in letters for mail-shots. You could have a list of potential customers for your business and target one area to receive a standard letter.

The only problems with this procedure is that, for disk users of *Protext*, you can run out of memory rather too easily if your main file is on the large side. The solution is to have more main files of a shorter length.

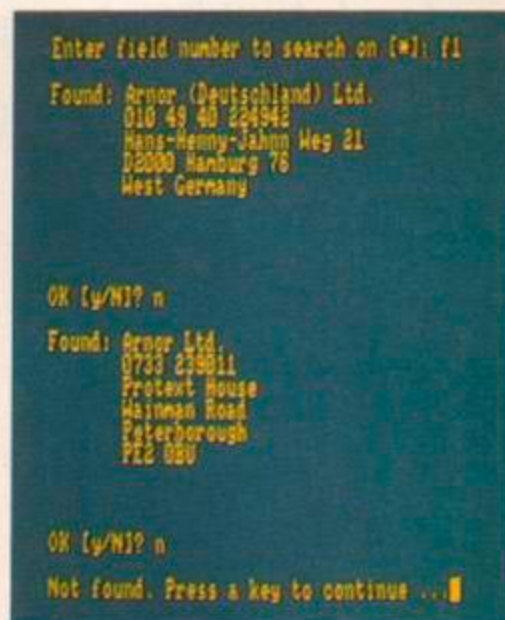

● Sorting out Arnor's address

### Who needs a manual? I do!

The documentation is at present supplied as a series of files on the reverse of the disk. Arnor have assured us that a manual is being produced. Over 200 people have already bought the product and these, and anyone else who buys it, will receive a manual when it is finally finished. The notes on using it are extensive (48 A4 pages) so don't expect to absorb it all at once.

### Deluxe Delights

From what you have just read, you should have some idea of the capabilities of *Protext Filer*. For an increase in price you can get the more powerful *Office*.

The only extra feature that you get is the option to print invoices. However, this is extremely well supported. For a start, you can configure the invoice as it goes on the page. You can either select to use the filing system to provide customer information or you can input it manually.

It is possible to set up a product file, on which you can store price information for each item that will require invoices. If needed you can create up to five different discount schemes, and also special/normal/exempt VAT rates.

Arnor themselves have been using the invoicing system for over two years. It really is of a very high standard - each invoice is logged as it is created. Copies can be reprinted very easily, and you can choose to either let the computer number them from one upwards or have your own system of keeping track of which invoice number has been used.



GOOD NEWS	BAD NEWS
<ul style="list-style-type: none"> <li>■ Easy to set up file systems using <i>Protext</i></li> <li>■ Powerful sorting options.</li> <li>■ Invoice Printer is comprehensive.</li> </ul>	<ul style="list-style-type: none"> <li>■ No manual at present.</li> <li>■ Can be slow going from one option to another.</li> </ul>





Bear in mind that adding this to your system will be of greater benefit if you have both *Protext* and *Promerge* on ROM. CPM *Protext* is alright, but if you use the Amsdos disk versions then I'm afraid you will lose some of the power and capacity of *Protext Office*.

To sum up, *Protext Filer* is an excellent addition to Arnor's range. It gives a great deal of flexibility in setting up indices for various purposes, especially name and address files. The invoice totting *Protext Office* is definitely good news for the CPC business community. More please Arnor.

Arnor, Protext House, Wainman Road, Peterborough PE2 OBU.  
(0733) 239011

## Video Control System

James Blair Systems, £99.95 CPM+ disk only

Since the days when the Amstrad was launched, there have been plenty of general packages available, but few programs dedicated to just one task. This program fits in that bracket: it can help run a small video hire shop.

What you receive for your money is two disks and four separate booklets. The whole lot was written using C-Basic and GSX, so to get into the suite you need to use CPM+. The *Video Control System* provides different costs for different videos, lease facilities and is able to cater for the various formats.

Two different sub-programs are provided in order to input information into the system. These are:

**Stock Movements** - up to 100 films can be pre-booked, and 500 hires and 500 returns can be recorded before the system needs updating. Your video library had better not exceed 2300 films.

**Membership Movements** - lets you update and keep track of the members of the video club. Free membership is catered for, and a total of 2000 members can be kept at once.

To analyse this information, you use one of the many report func-

### Deceptive appearances

Being written in Basic running under CPM+, you might think that the *Control System* was rather slow. Actually the Basic is compiled, and so manages a fair lick, with one exception - the end-of-day routine generally needs to run overnight.

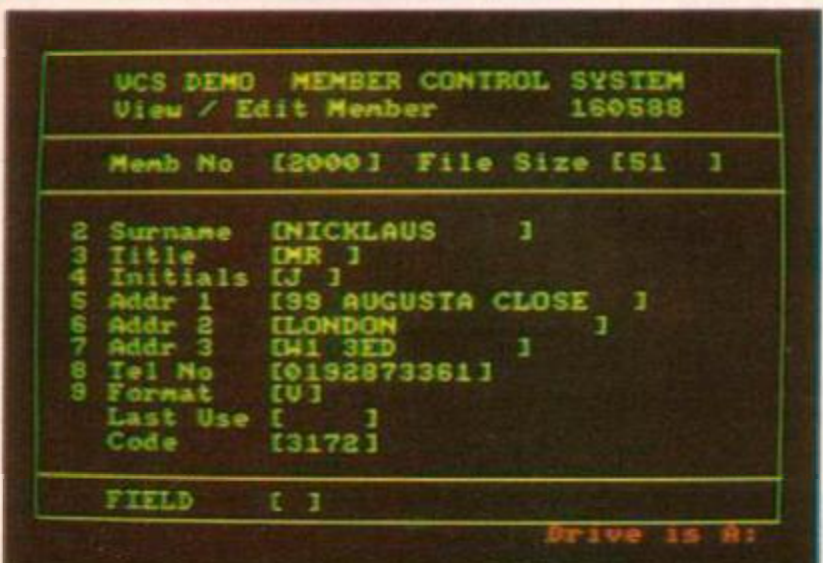

tions. A few of these are: stock listings, inactive stock, top 10 videos, membership register and inactive membership. All of these can be dumped to a printer. There is also a function to print labels.

James E Blair

21 Torranyard Terrace, Wellbrae Park, Hamilton, ML3 8XG (0698) 821319

### Out on hire

In use the whole system behaves very well, every page being filled in as you go along. A CTRL key sequence can be used to go back to sub menus, and the RETURN key must be used after each entry.

The suite is supplied on two disks and comes with four A4 sized booklets. These are a system manual which explains each function, a system specification which tells you just how to operate it, some sample reports, and a license agreement which explains just how much support you get.

You see, for the rather large price Mr. Blair offers a large slice of software backup. He wrote the program and so can help where a salesman would flounder. The membership and video numbers will also be set up to your liking, and it goes without saying that the name and address of your company is put in as standard.

In conclusion, let me point out that according to Mr. Blair the nearest priced competitor costs £400+. The *Video Control System* therefore represents a good investment for the small video shop owner.

#### GOOD NEWS

- Easy to use.
- Good documentation.
- Cheap for what it provides.

#### BAD NEWS

- It still costs a lot.
- End-of-day routine is slow.

## Industry Comment

So, the software is available. But who actually uses the CPC in their business? We went out to talk to the people who depend on these versatile machines to earn their living, and ask them how useful they are for work rather than play.

**Abbas Darweish** is a graphics designer who lives in Winchester. He read the AA32 review of SD Microsystems *General Ledger*, and thought this would suit him down to the ground.

"My only problem with the system is that I can't input a receipt number into the transaction. Apart from that, it's perfect."

Does he use his CPC664 for actual design?

"Well, my problem is that I can't find a good enough Desk Top Publishing program - not one that works on a 664. If I could, then that would be great. I also can't send control codes to my local typesetters via a modem at present, which is a real shame."

How about general office paperwork?

"I find *Tasword* is adequate for writing letters, etc. *Mini Office 2* is a very good tool for drawing graphs and pie charts. It can handle a lot of tasks much easier than doing them by hand."

So what do you think about the CPCs in small businesses?

"Look, there are lots of ways to put the machine to use, apart from playing games. I can do an invoice in no time at all, and my accountant is very happy about getting printed ledger accounts. At the end of the day the Amstrad is helping me to make money, because presentation is everything in this business."

**James Fielding**, from Melksham in Wiltshire, has a business producing badges for various customers. What does he use it for?

"To start with, we were very limited by what we could and couldn't do. We had a plotter that didn't do what was needed, the Amstrad couldn't talk to it. We gradually built it up. First I learned how to work the plotter using HPGL (Hewlett Packard Graphics Language). That way I could draw what was needed. Then a friend of mine built an 8-bit interface for the printer port."

Surely it couldn't have made that much difference?

"This interface was special in that it converted from a parallel to a

**!! NOW SPEEDTRANS PLUS HAS EVEN MORE TO OFFER !!**

## SPEEDTRANS PLUS2

For CPC6128 (or 464/664 with DK Tronics 64K (or larger) Memory)  
Once the programs has been transferred to disc IT WILL RUN ON ANY CPC.

**SPEEDTRANS PLUS2** now handles the VERY LATEST Speedlock types automatically. No need to hold a key down at anytime during loading. **SPEEDTRANS PLUS2** also saves 99% of opening screens and saves them in their full colours

FULLY AUTOMATIC - JUST ONE KEYPRESS \* ONLY ONE PROGRAM TO RUN WHICH FINDS THE SPEEDLOCK TYPE AUTOMATICALLY \* WILL TRANSFER ORIGINAL AND MANY OF TODAY'S SPEEDLOCK PROGRAMS \* NO FIDDLING OR MEDDLING - WRITTEN WITH THE AMATEUR IN MIND \* AUTOMATIC DISC FILENAMES \* NO WASTED DISC SPACE - SAVES THE CORRECT AMOUNT OF GAME CODE \* SAVES 99% OF OPENING SCREENS \* SCREENS SAVED IN THEIR CORRECT COLOURS \* COMPRESSES SCREEN CODE TO SAVE EVEN MORE DISC SPACE \* FASTER LOADING TIMES FROM DISC BECAUSE OF SHORTER FILE LENGTHS

**SPEEDTRANS PLUS2** transfers over 200 programs to Disc, some of the latest it will do are MADBALLS, FREDDY HARDEST (both games) BASKET MASTER, MATCHDAY II, PHANTOM CLUB, GRYZOR (main program), SUPER HANG ON.

These latest Speedlock types can be identified by the whole screen flashing with horizontal bands of colour immediately after the first file has loaded. Do remember that **SPEEDTRANS PLUS2** does not save all the memory in the hope of having saved all the game. It saves exactly the right length of code. All screens are saved in compressed form - some as little as 4K (Basket Master) - thus saving even more disc space.

**SPEEDTRANS PLUS2** is the most sophisticated Tape-to-Disc transfer utility for SPEEDLOCK protected programs ever published. It will certainly transfer more games than any other Speedlock transfer program on the market and with much greater ease. Other transfer programs require you to know how long the game code is so that you may run an alternative program for the long games which does not save the loading screen. This is done because they do not make use of the extra memory available on the CPC 6128 or from the use of an extra RAMPACK (DK Tronics 64K or greater.) This program is highly intelligent in that it first reads the loader from the tape and establishes which type of protection is in use from 6 alternatives. At the end of the load it then finds out how long the code is and if it is too long to be saved to one file it will move the excess code into the banked memory and save the game in two parts and write the appropriate loader program. The screen will also be moved into a bank and compressed before saving. This can mean screen files as small as 4k (Basket Master) depending on mode and content. All this adds up to a lot less disc space being used than with other transfer programs and you will nearly always get the loading screen saved. The exception to this is when there is no loading screen (as in SCRABBLE) or when the screen is blanked out and more code is loaded into the screen memory, as in BMX SIMULATOR and MADBALLS for example. Try getting a screen with Multiface or any other imager. These imagers are only capable of saving what you have in memory at the time the button is pressed. What happens in multi part games? you have to press the button for each part thus wasting precious disc space. They also save far too much code and therefore waste even more space and saving too much code means longer loading times from disc. Programmers are now checking to see if you have an imager plugged in if you have the program will not load. Imagery also have to be in place before you can reload your program and saved programs can only be reloaded in to the machine in which they are saved. **SPEEDTRANS PLUS2** creates totally stand-alone files and if you have nother CPC even without extra memory they will run perfectly. It also displays the saving name on screen at the start of the load with all except the very latest games. In all cases the disc saving name is displayed while the save is carried out. To run the transferred game just RUN this name. Another intelligent feature of **SPEEDTRANS2** is that the very first thing it does is to find out which drive it is in. This means that if you have a two drive system you may run the program from drive B by typing RUN 'B:DISC' or 'B:RUN'DISC. However the saving will ALWAYS be to DRIVE A so with a single drive you must change the disc when prompted on screen.

DISC:- UK £14.99 - EUROPE £16.25 - REST OF WORLD £17.00

Upgrade your **SPEEDTRANS PLUS** - send your disc together with: UK £2.00 - EUROPE £3.25 - REST OF WORLD £4.00  
Upgrade your **SPEEDTRANS TAPE** send your tape together with: UK £12.00 - EUROPE £13.25 - REST OF WORLD £14.00

**\* LOW LOW PRICES \* ARNOR SOFTWARE \* LOW LOW PRICES \***

Program	UK - Disc		Europe - Disc		Rest of World - Disc	
	Disc	Eprom	Disc	Eprom	Disc	Eprom
PROTEXT OFFICE *NEW*	29.50	N/A	30.75	N/A	31.50	N/A
PROTEXT FILER *NEW*	19.50	N/A	20.75	N/A	21.50	N/A
PROTEXT	21.50	34.50	22.75	35.75	23.50	36.50
PROSPELL	19.50	29.50	20.75	30.75	21.50	31.50
PROMERGE (ROM=PROMERGE PLUS)	19.50	29.50	20.75	30.75	21.50	31.50
MAXAM *THE BEST!*	21.50	34.50	22.75	35.75	23.50	36.50
MAXAM 1 1/2 *NEW*	N/A	24.50	N/A	25.75	N/A	26.50
UTOPIA	N/A	24.50	N/A	25.75	N/A	26.50

Purchase the Rombo romboard and we will give you a further £3.50 discount on each rom program

**ROMBO ROMBOARD** UK - £31.00 EUROPE - £33.00 REST OF THE WORLD - £35.00

### DMP 2000/2160/3000/3160

The printer buffer presently in the DMP 200/3000 series is a 2K RAM. Most of this RAM is used by the printer's operating system leaving an average 1/2K as buffer space. Our upgrade kit contains a new static RAM chip which will increase the printer buffer by 6K (about 4 pages of text). This upgrade allows all Download Characters to be re-defined allowing the user to design special characters for use with scientific and other programs. The kit is supplied with full pictorial instructions to allow the amateur to carry out his own modification (the DMP2160 takes about 7 minutes). If you don't think you are up to it your local TV shop can do the job in approximately 15 minutes

UK £9.00 - EUROPE £10.25 - R. of W. £11.00

### FIRETRANS

This utility will transfer a number of FIREBIRD programs from tape to disc automatically including most opening screens in full colour. **FIRETRANS** will work equally well from tape but will be more convenient to use if converted to disc with **SAMSON/Transmat**. It will transfer WILLOW PATTERN, RUNESTONE, CHIMERA, GUNSTAR, PARABOLA, REALM, SPIKY HAROLD, BOOTY, DON'T PANIC, GUNFRIGHT, STARGLIDER, NINJA MASTER, HELICOPTER, and some version of THRUST, HARVEY HEADBANGER and BOMBSCARE.

TAPE:- UK £5.00 - EUROPE £6.25 R. of W. £7.00  
DISC:- UK £8.50 - EUROPE £9.75 - R. of W. £10.50

NEW

### COMPACTOR

NEW

**COMPACTOR** will allow you to load a standard 17K screen, set the mode, border and ink colours and then save it as a compressed screen containing its own mode and ink colour information. Most screens compact down to an average of 9K which is an enormous saving on disc space. Loading time of compressed screens is also proportionately reduced.

TAPE:- UK £5.00 - EUROPE £6.25 R. of W. £7.00  
DISC:- UK £8.50 - EUROPE £9.75 - R. of W. £10.50

### FAST FORMATTER

The **FASTFORMATTER** will format one side of a disc in approx. 30 seconds with the choice of DATA, VENDOR or SYSTEM and its much easier than using your CPM disc.

TAPE:- UK £4.50 - EUROPE £5.25 - R. of W. £6.50  
DISC:- UK £8.00 - EUROPE £9.25 - R. of W. £10.00

### TRANSIT

**TRANSIT** is a disc-to-disc file copier which handles file upto 40K in length in one pass. It will copy from drives A-A, A-B, B-B and B-A making an ideal utility for use with 5 1/4" second drive.

TAPE:- UK £4.50 - EUROPE £5.25 - R. of W. £6.50  
DISC:- UK £8.00 - EUROPE £9.25 - R. of W. £10.00

### UTILITY DISC No. 1

This utility disc contains 5 programs, all menu driven. They are **SAMSON**, **TRANSIT**, **QCLONE**, **VIEWTEXT** and the fast disc **FORMATTER**.

DISC:- UK £15.50 - EUROPE £16.75 - R. of W. £17.50  
ROM:- UK £17.25 - EUROPE £18.50 - R. of W. £19.25

### 3" PANASONIC DISC BOXES

Rumour has it that Amsoft/Panasonic no longer supply boxes with their discs. We have approx 1000 boxes remaining at 25 pence each. Regretfully we can only supply boxes if accompanied with a minimum order for Software/hardware of £15.00 unless extra monies are enclosed to cover postage.

NEW

### NIRVANA

NEW

Have you tried backing up your original expensive disc software and failed? Use **NIRVANA** before its too late! **NIRVANA** (meaning enlightenment) is an extremely powerful disc handling utility which has the following features: Disc to disc back-up copier which will handle most of the commercially protected discs available today. File copier for individual files. Disc formatter, much easier to use than CPM. Change file attributes. Erase files. Change filenames. Will handle all disc drive combinations

DISC:- UK £14.99 - EUROPE £16.25 - R. of W. £17.00

NEW

### SHAREPLAY

NEW

THE STOCK MARKET SIMULATION  
(All CPC's)

This is a serious educational program for 1 to 6 players and provides all the enjoyment of playing the stockmarket without any risk of personal bankruptcy!! Each player can buy and sell shares and the target is the first to reach £1,000,000. The program includes a stockholding portfolio listing the shares purchased, their number, cost and market value. Bank balances are also shown. Graphical representation of market fluctuations are given in the form of a bar graph. Also included is a high score table. Scores are automatically saved at the end of each session.

DISC:- UK £14.99 - EUROPE £16.25 - R. of W. £17.00

NEW

### WORDSEEK

NEW

THE WORDSEARCH PROGRAM  
(All CPC's)

This educational program will tax even the most agile mind. The aim is to find the hidden words in a 15 by 15 puzzle within a set time limit of 30 seconds. The time limit is extended for every correct letter of the current word found. You may create your own puzzle consisting of up to 10 words which can be saved to disc and used at any time. You may only retain one puzzle at a time but if you choose not to use your own puzzle then the program will randomly select one from the library of 50 on the disc. All of the puzzles in the library are made up of 10 words each consisting of 1x8 letter, 1x7 letter, 2x6 letter, 3x5 letter, 2x4 letter and 1x3 letter words. This ensures equal difficulty regardless which one is randomly loaded. The program contains a print option (for Epson compatible printers) allowing a hard copy to be made of any puzzle created. Keyboard/Joystick options are also available.

DISC ONLY - U.K. £14.99 - EUROPE £16.25  
REST OF THE WORLD £17.00

NEW

### TUNESMITH

NEW

**TUNESMITH** is a simple to use sound utility which allows you to use the keyboard to play and record your tunes. No knowledge of music or Amstrad sound commands is required all you need to be able to do is whistle the tune you play or record. The octave and period of notes is variable and the program includes synthesizer and vibrato effects. **TUNESMITH** will save any tune as a basic file which can be RUN, CHAINED or MERGED into your own program.

DISC:- UK £14.99 - EUROPE £16.25 R. of W. £17.00

### SAMSON

**SAMSON** has been developed by us to transfer not only the normal programs but also many of today's where the code is much longer. **SAMSON** differs in many ways from other Tape-to-Disc utilities, the main differences being: \* **SAMSON** retains original file suffixes (**SAMSON.SCN** will be saved as **SAMSON.SCN**) \* Improved file relocation method \* Elaborate Tape-read/Disc-write system which reduces Tape Motor, Slave Replay and Disc Drive Motor wear substantially. \* A large reduction in tape transfer time is also achieved in all but a few cases \* NEW "SPLIT" option for today's longer games (we will be using this option in future routines) \* All file information is displayed on screen and can be echoed to your printer if needed. **SAMSON** also transfer itself to disc.

TAPE:- UK £7.50 - EUROPE £8.75 - R. of W. £9.50  
DISC:- UK £11.50 - EUROPE £12.75 - R. of W. £13.50

### CHARACTER DESIGNER

(All CPC's)

\* REDEFINE YOUR PRINTER DOWNLOAD CHARACTERS  
\* REDEFINE THE COMPUTER SCREEN FONT  
\* REDEFINE ANY/ALL KEYBOARD KEYS (ASWERTY)  
\* DESIGN SPECIAL SCIENTIFIC CHARACTERS FONTS

Takes all the hard work out of character designing making it a pleasure. The printer part of the program will only work if your printer is capable of DOWNLOADING and is EPSON compatible - see your printer manual. Works with 7-bit or 8-bit output (8-bit port). All the designing is done "On-Screen" so you can see exactly what you are doing. You can save your newly designed characters to disc and reload them at any time into a basic program and into most Word-Processors. The program also allows the user to redefine any or all of the keys on the keyboard. This feature will be useful for those who require an ASWERTY keyboard. The disc also contains twelve sample fonts for experimentation

TAPE:- UK £7.99 EUROPE £9.25 - R. of W. £10.00  
DISC:- UK £11.99 - EUROPE £13.25 - R. of W. £14.00

### DISC HEAD CLEANING KIT

Stocks of these 3" head cleaning kits should arrive within the next few days. HIGHLY RECOMMENDED.

UK £8.00 - EUROPE £9.50 - R. of W. £10.00

Please send your cheque (£ Sterling) Eurocheque OR UK P.O. to  
GOLDMARK SYSTEMS, 51 COMET ROAD, HATFIELD, HERTFORDSHIRE,  
AL10 0SY, ENGLAND

Please write or telephone 07072 71529 for full brochure.

serial transmission. Which means that now we can pump HPGL straight into the plotter. I don't know anything about how the Amstrad works, and I don't want to. A little BASIC to help me, well that's okay."

So you use the CPC to actually design the badges?

"Treasure Island supplied us with *Parrottry* and *Parrottry Plus*. While there is a lot of things that they can accomplish, such things as circles look very crude. So for the special parts we use HPGL. The overall results are very good. Students are very interested to see our setup in operation."

## Exclusive Software

Most people use general software on the CPC for their small business. However, there are a few specific products available, all on disk only. SD Microsystems are a small company who produce three products for the CPC only. The first is the *Small Trader's Pack*, reviewed in AA26, which costs £24.95. This comprises accounting facilities, stock control and mailing lists.

Also reviewed in AA26 was their *Sales Invoicer Pack*. It includes the same sales ledger as the *STP*, and also a sales invoicer plus a statement generator. It can be used independently of the above product, and is priced at £14.95

A complimentary product to the *STP* is the *General Ledger*, which was reviewed in AA32. This is quite a powerful piece of software which can keep track of up to 40 accounts. Each one can be set up to your specification, and includes printout routines to show to your accountant. (It is not, however, suitable for a large business.) It costs £24.95.

On a slightly different tack, Meridian Software produce *Stockmarket*. This is an interesting program which is used to keep track of one or more small portfolios of shares. It is a little involved for the beginner but can teach you a lot about the subject. One major let down is that you cannot copy graphs onto paper without a separate program. *Stockmarket* sells for £29.95.

### Contacts:

**SD Microsystems**, (0462) 675106, PO Box 24, Hitchin, Herts, SG4 0AE.

**Meridian Systems**, (01) 8507057, 38 Balcaskie Rd, London, SE9 1HQ.

How about your paperwork?

"We use a lashup - well, it's a printing program of a sort. A large number of printing templates are held on file, including standard form letters. When we need to print something, we find the closest template, alter it and then print it. Not your conventional word-processor. We also use the Minerva Systems database."

Couldn't you have used a different machine for all these tasks? Why use a CPC?

"The important feature of these computers is that they are hybrid machines. They can handle colours and sound, they have disk drives and CPM, ample memory and a screen swapping capability. They have everything for a small business."

**John Moore**, from Middleton County Cork, used to use a CPC6128 in his business, Modern Art Aluminium Ltd. Two weeks ago he scrapped this situation and started using an IBM system 2. Why?

"Well, we were using *Supercalc 2* and *Masterfile*. The programs themselves were okay. The problem was that plenty of our disks contained bad sectors. Having an error message leap out at you when you start CPM+ is very annoying."

"Another problem was the lack of space, both in memory and on the disks. You can't get at the extra 64K of memory without using *Bankman* and understanding programming a bit. In the end we just grew too big to use it."

"Sugar-daddy seems to have this idea that Ireland isn't a viable market. We can read magazines and see the stuff, but we can't go out and buy it. I had to use mail-order to buy my software. There just isn't enough support over here for the CPCs to be small business machines."

**Caroline Downham**, from Amway Uk Ltd, uses a CPC plus Arnor's *Protex* and *Promerge Plus* on ROM. Amway is part of a multi-million

pound corporation, so how come she uses the humble CPC?

"Well, I went to a few computer shows and got my present system. Then the managers decreed that we would all be getting *Wordstar* on PCW8256. Well, I wasn't!"

"I'm a very strong-willed person, and to cut a long story short I kept my CPC. Now a lot of the office people are envious of the things I can do. In fact, a few people have changed over to *Protex* and before long I expect the management will make it the "official" word-processor."

What do you find so special?

"The most useful feature of the system is that I can edit two documents at once. If you include the printer buffer then that makes it three documents. I'd be useless without those, really."

"We have a number of affiliated European companies, and in talking to them I have found that *Protex* is a clear winner whenever it has emerged."

"One day I'll upgrade to a bigger machine, but for the moment the CPC can help me deal with all my problems. Software on ROM is so convenient."

**Martin Seymour-Smith** is a writer. He does free-lance work for the *Financial Times*, and has written over 30 books. How useful does he find his CPC6128?

"Let me state that I've only recently been using my CPC for writing. I've just completed a 250,000 word book on Rudyard Kipling, called, funnily enough, *Rudyard Kipling*. But I have written books over a million words long, and I wish I had had *Protex* then."

Don't you find adding prose together rather cumbersome?

"Well, no. I think the sheer speed of the system more than justifies having to add parts of a book together."

"I started out using *Tasword*. This was alright in itself, but very slow. Next I got *WordStar*, which was a real nightmare. I tried *NewWord*, which was the best up to then. Finally I got *Protex*."

Is there anything special about having the CPC?

"Having the ROM version is important to me, in terms of convenience." (*Protex* for CPC is available on ROM. Try getting a ROM for a different computer - you can't.) "Personally, I think it's as good if not better than dedicated word-processors, costing thousands of pounds. If I had to buy again I'd go once more for the system I've got now."

**D Roper** uses his CPC within his four companies: Jolly Motors UK, Blind & Shatter Services, Telcoma UK and Suncover UK. Does he find the CPC of any use?

"What I use at present is *Mini Office 2*, which is a little underpowered for my needs. I also use *Protex Office*, which I find excellent for what it provides. What I would really like to see is an integrated accounting package from Arnor, using *Protex*, *Promerge*, *Prospell* and *Protex Office*. That would be excellent."

How exactly do you use your system in your business?

"My main priority is using *Commstar* to send telex's. I generally need to send 10-15 telex's per day. That's one task that it can handle. *Protex Office* I use as a database and invoice printer - it's very good. And naturally I use the word-processor for my paperwork."

Are you satisfied with your software as is?

"I don't believe that the Amstrad's full capability has been exploited by software. Don't get me wrong, I think Arnor are the people to do it. But it hasn't really happened yet. One final point - I do wish your reviews of business software would talk up to the business user. I find it irritating that you write as if every reader will be interested in reading such reviews."

## Conclusions

It would seem that a number of people prefer the CPC for its graphic and sound capabilities. Some people use it because of a particular software package - mainly ROM *Protex* users. No doubt its price contributes to the popularity. And generally, most people stop using CPC's because it lacks the memory, not the power, to do the tasks they demand. We want to continue following the progress of the CPC in business, so if you've got any products or information that might benefit fellow CPC business users, then let us know.

# WORDS WORK

## How to get the most from your word-processor and printer

Last month I explained some of the differences between various printer types, and their relative merits. The follow on from that subject is of much more fundamental importance – finished print quality, or how your stupendous documents appear on paper.

It is all too easy when tapping merrily away at a word-processor to get caught up in the necessities and mechanics of writing. However well written a piece is, it must be attractive to the reader.

Of course, tapping away at an Amstrad word-processor might seem enough. It could be that you're perfectly happy with your letters, and don't see any need to improve them. However, by the same argument, why use a word-processor at all? Why not a typewriter, or just write things by hand?

You want to produce neat, readable results. You want the instant editing facilities of word-processors, the ability of storing documents on disk, spell-check programs and many more. These days though, other people have the same word-processor, computer and printer. One letter can look very much like another: what is needed is a sort of renaissance back to the individual, hand written days without the attendant loss of processor power.

Plenty of people will be screaming anathema by now. Are all the skills they spent years perfecting useless? Is a word-processor leading them down a blind path of utilitarian uniformity and blunting writer's creativity? Are the computer's end results a fools paradise?

Errrm, no. Enthusiasts are, by the very nature of their label, obsessed with gaining nirvana. I am never satisfied with any one sentence, and given time will reach for a thesaurus to rectify and sharpen all I can. But that is strictly the creative part of me attempting to better a result. This article is aimed at informing people how to produce documents that have a particular look and style, without reference to their content. It's not a grammar lesson.

### Letterheads

Let's start at the top. The first thing people notice (if present) is a letterhead. This doesn't have to be fancy, but needs to be eye-catching and of interest. Mega-corporations invest millions to try and select the right corporate image. You probably won't want to go quite that far, but choosing a letterhead is a serious business.

Look at some that you've received, and try and analyse their qualities. Generally they contain names, addresses and telephone numbers, rather than having a simple block of text at the top. A picture or even better a company logo come high on the list of priorities.

It's time to talk about how you get your wonderful design in reality. Small printing firms can supply letterheaded A4 for about £30 per thousand sheets if you supply them with a master to work from: you may well be able to find a cheaper source.

Alternatively – and this is what an awful lot of people do – they actually print the letterhead themselves. We have received a number of programs to do this, although generally they have not been suitable for publication. The drawback with this method is that unless you have a colour printer or plotter, the result will be in black and white.

A favourite dodge is to design something with a graphics/art package and then do a screen dump with it. The only problem with

this approach is that each piece of letterheaded paper needs about 5 minutes printing time before your word-processor gets to work! Occasionally people do a master, and then photocopy it. The results are crude but effective.

Next month we'll continue our look at presentation and go into more detail on the subject.

## Ways with Words

Do you have favourite tricks for getting the best out of your word-processor? Or do you have seemingly insurmountable problems? Share them with other Amstrad addicts. Send them in to: **Words Work, Amstrad Action, 4 Queen Street, Bath, BA1 1EJ.**

### Protex special

Boxes and graphs are possible directly from *Protex*, through the use of downloaded characters, variation in line feed spacing and reverse line feeds. Anyone interested should contact me, but here's the gist of it.

You will need:

i) *Protex* or any word-processor that will accept up to 12 printer control codes in its table. (*Tasword* only has five spare, so you'll need to ditch some first.)

ii) An Amstrad DMP2000 or Epson compatible printer capable of downloading characters, reverse and variable line feeds and underlining.

First, type in and copy the following program which downloads characters to the printer onto the working *Protex* disk. You run it each time you use the disk.



```

10 'Boxes using Protex
20 'Neil Robertson 25.04.88
30 'Amstrad Action July 88
40 '
100 CLS
110 PRINT "Please Switch on your printer"
115 PRINT "And HIT A KEY to download characters"
120 PRINT
130 PRINT "or reply NO....."
140 x$=INKEY$:IF x$="" THEN 140
150 IF UPPER$(x$)="N" THEN 230
160 FOR n=2 TO 6
170 PRINT #8,CHR$(27);"6";CHR$(0);CHR$(n);CHR$(n);CHR$(11)
180 FOR d=1 TO 11
190 READ c
200 PRINT #8,CHR$(c);
210 NEXT d
220 NEXT n
230 RUN "protex"
240 DATA 0,0,0,0,127,0,0,0,0,0
250 DATA 0,0,0,0,15,8,8,8,8,8,8
260 DATA 8,8,8,8,15,0,0,0,0,0,0
270 DATA 0,0,0,0,120,8,8,8,8,8,8
280 DATA 8,8,8,8,120,0,0,0,0,0,0
290 END
    
```

Next, a printer driver can be set up and saved as "pdriver" to the same disk. Press printer control letter(A to Z).

Reset Printer @

## Tasword unlocked

While trying to carry out some tricky manoeuvres with *Tasword* we stumbled across the following commands for short circuiting the main menu. It saves time particularly with the frequently used options. You must select the keys you want to utilise and add 184 plus the ASCII value to the key specification in the *Tasword* Basic program. The following are the relevant ASCII codes for the option menu.

Print text file	P 80
Print with Data merge	D 68
Save text file	S 83
Load text file	L 76
Merge with text file	M 77
Return to text file	R 82 (fairly pointless)
Customise program	C 67
Save <i>Tasword</i>	T 84
Erase file from disk	E 69
Into Basic	B 66
Check Spelling	K 75
Install <i>Tasprint</i>	I 73

Say you replace line 50 (at present 50 KEY 3, "3") to read 50 KEY 3, CHR\$(184)+CHR\$(80). Then when using *Tasword* you only need to press the CTRL and the f3 keys, and you will be put straight into the print mode. 50 KEY 3, CHR\$(184)+CHR\$(83) will get you into the save mode, etc.

This may prove useful to those like ourselves who use two disk drives, and normally have *Tasword* with *Taspell* on drive A, and the text file storage on drive B. Edit line 160 of the Basic program and put B: as the first command of this line. You will find *Tasword* automatically selects drive B.

Please, can anyone suggest what can be done to remove the brief help paragraph. CTRL & 2 will remove it while using the program, but we don't want to start with it!

Michael and Stephen Fecher

WET SEASON CROCODILE ATTACKS, Queensland and Northern Territory 1988.

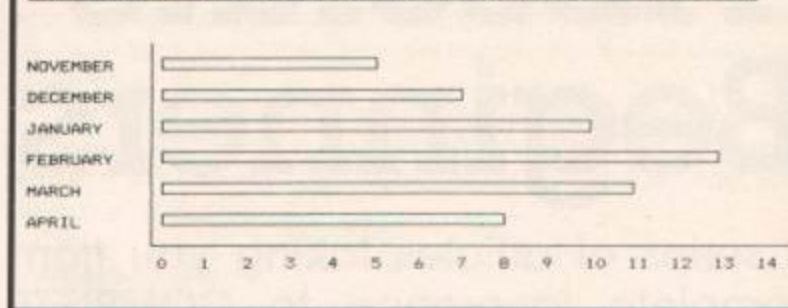

By using these codes, perfect boxes can be drawn around text or to form graphs. The reverse line feeds are used after the text and before the change of line spacing, so that:

- i) The text is printed.
- ii) The paper is reversed by the same number of lines.
- iii) The line spacing is changed and the box is drawn around the text.

Lastly, you can alter the loader program on the *Protex* disk so that the printer driver "pdriver" is automatically used.

This setting up may seem complicated. However, with a little practice the box drawing modification is easy to use.

Neil Robertson, 15 Canaris St, Wanguri, N.T. 5792, Australia

## Forging sterling

I have *Protex* on ROM connected to my CPC6128. I find it an excellent word-processing program and use it with an IBM badged personal computer graphics printer (IBM 5152), which is an Epson type tractor fed 9 pin dot matrix printer.

The one small problem that I have is that I cannot get the printer to print a pound sterling sign. When shift ^ is keyed it prints a heart, a hash then a heart. Help!

Richard M Hughes, Stirling

*It is necessary to change the printers internal character set to English. Consult your manual on which dip switches to flick. The drawback with this is that you then can't use hash (#) symbols, as this is used for the pound sign. A case of swings and roundabouts.*

## Brunword clarification

Last month in the Buyers Guide it was stated that *Brunword* 6128 files cannot be loaded into other word-processors. *Brunword* version FH files can be loaded into *Tasword* or any other word-processor that can load ASCII files, similarly ASCII files can be loaded into *Brunword*.

To load or save an ASCII file press ESC to get to the main menu, with the main menu displayed press A. You will then see the prompt LOAD or SAVE appear at the bottom of the screen. To load a file press L to save a file press S. It should be noted that option A does not actually appear on the main menu but, it is available. See the manual page 9 section 4.

The only drawback being that some characters such as fixed spaces have to be altered when loaded into *Tasword*

Les Ashton, Scunthorpe

*What I was trying to say in a confined space was that standard Brunword files can't be loaded into other word-processors. Thanks for pointing out just how to do it.*

## Protex revisited

I have discovered a bug in *Protex*. In the console, type R, then a word, then enter, then enter again. You will get a huge - 500 columns is not unusual - lines of control hieroglyphics. After this the program is beyond redemption, so don't do it on a document you treasure! This happens with version 1.08 (disk) on a 464.

Rabbi Bajzheet, New Zealand

	a 27 37 1 0 27 73 1 2 27 37 0 0	
Bold (emph.)	b 27 69	27 70
Condensed	c 15	18
Double-Strike	d 27 71	27 72
Elite	e 27 77	
Font Change 1	f 27 82 1	27 82 3
Font Change 2	g 27 82 1	27 82 3
	h 27 106 12 27 45 49	27 45 48 27 74 12
Italics	i 27 52	27 53
	j 27 37 1 0 27 73 1 3 27 37 0 0	27 37 1 0 27 73 1 4 27 37 0 0
	k 27 37 1 0 27 73 1 5 27 37 0 0	27 37 1 0 27 73 1 6 27 37 0 0
Enlarged	l 27 87 49	27 87 48
	m 27 51 21	27 50
Normal (Pica)	n 27 80	
	o	
Proportional	p 27 112 49	27 112 48
NLQ	q 27 40 27 120 1	27 120 0
	r 27 106 36	
subscript	s 27 83 49	27 84
Superscript	t 27 83 48	27 84
Underline	u 27 45 49	27 45 48
	v	

The points to note here are:

- i) The absence of a reset code.
- ii) The "a" code prints the downloaded vertical bar.
- iii) The "h" code moves the paper half a line up and switches on underlining. (Another "h" to end.)
- iv) The "j" code prints the top left corner. (Next "j" is top right corner.)
- v) The "k" code prints the bottom left corner. (Next prints bottom right.)
- vi) The "m" code switches the line spacing to 21/216 inch. (Next one returns to 1/6 spacing.)
- vii) The "r" is a reverse line feed.

# Absolute Beginners

A series of articles taking you from complete ignorance to COMPLETE mastery of Basic

## The story so far...

Last month we took a brief look at some of the graphics commands. We will now expand on this knowledge and see how to make the Amstrad go round in circles.

You've got a program which draws a square in the middle of the screen. Now suppose you want to draw the same square somewhere else on the screen - at the left-hand side, for example. The question is, how are we going to modify the program to do this?

The obvious way is just to use **EDIT** on each side of the program's lines in turn, modifying all the "distance from the left-hand side" of the screen's coordinates - the first operands of **MOVE** and **DRAW**, in other words. This is going to take you quite a while, and it's pretty boring stuff. If you feel you need the editing practice, go ahead - but there's a much better way.

With our program as it stands, we have to alter every line of it just

to change where it draws the square. Later on we're going to want to change the square's position over and over again, so we'll need to do something to make life easier. Alter the program using **EDIT** so that it looks like this:

```
10 CLS:MOVE a,180
20 DRAW b, 180,1
30 DRAW b,220,1
40 DRAW a,220,1
50 DRAW a,180,1
```

and then add a new line 5, which should read...

```
5 a=300:b=340
```

When you've done all that, **RUN** the program. You should get a square drawn in the middle of the screen, just like before. So why go to all that effort editing the program? To find out, type in this replacement line 5.

```
5 a=0:b=40
```

...and **RUN** the program again. You should now have a square drawn on the left-hand side of the screen - and you only had to change one line to get it there. Change line 5 to:

```
5 a=599:b=639
```

...and the program draws the square over on the right. Again, you only have to change one line. As you can see, that editing you did has made things a lot easier. Now, how does the modified program work? In particular, what does line 5 **a=300:b=340** do. The colon tells us that

# First Bytes

So, hexadecimal horrifies you? Richard Monteiro has the solution, in this section devoted to the novice machine code programmer.

Did you discover the delights of double-poke dealing? Well, don't worry if you didn't, as all will shortly be revealed. Cast your mind back to last issue. We published a short line of Basic - 10 **PRINT "This is a BASIC program."** - and proceeded to **PEEK** and **POKE** it. Rude that may sound, but those instructions are instrumental in finding out how numbers are stored in memory.

If you remember we first **POKE**d location 370 with a number (**POKE 370, 30** for instance) and then **LIST**ed the program. Try it now. Enter the one-liner, type **POKE 370, 30** followed by **RETURN** and then type **LIST**

## Programmer speak

It's time to familiarise yourself with some of the much-flung programming phrases. In forthcoming issues we shall jump straight into jargon, so don't get caught out. Gen up on the terms, today.

**Bit** - the smallest value that can be manipulated by a computer. It can either be set or reset; 1 or 0.

**Byte** - term for any eight-bit binary number, that is, any number between 0 and 255 (1111111<sub>2</sub>).

**Hexadecimal** - base 16 counting. Uses symbols 0 to 9 and A to F.

**Longword** - 32-bit number.

(again followed by **RETURN**). Assuming everything goes according to plan, you should find that the Basic program sports a new line number - the line number depends on the value **POKE**d into address 370 - 30 in this case.

Line numbers can be anything up to 65535. But changing the line number, as described earlier, only allows line numbers in the region 0 to 255 - which correspond to the largest and smallest values that can be held in any one memory location.

So just how do you get line numbers with values of 256 and above? The answer is by poking a 16-bit number (called a word) into location 370. It's not quite as straight forward as that because it is impossible to **POKE** an address (memory location) with a value above 255. Find out for yourself if you like. **POKE 370,256**. You'll get an improper argument error.

The way around this problem is to **POKE** location 370 with an 8-bit number and location 371 with another 8-bit number. Together they make a 16-bit number. However, to make things more awkward, 16-bit numbers aren't stored in memory in an immediately obvious manner. For example, try the following:

**Machine code** - consists of bits, bytes, nibbles, words, longwords.

**Memory** - the stuff that retains information: programs, data and so on. Ram (random access memory) for reading and writing to. Rom (read only memory) for... go on, guess.

**Nibble** - any value that can be expressed in four bits (0 to 15). Two nibbles make one byte.

**Peek** - Basic command to inspect the contents of a memory location.

**Poke** - Basic command allowing you to alter the contents of any memory location.

**Print** - another Basic command.

**Word** - two bytes or a 16-bit number in the region of 0 and 65535.

## The theory

As you can see **a** and **b** can change in value during the course of the program. Because of this, we call them variables. Commands which change the values of variables, like the ones in lines 5 and 45 are called assignments – because they assign new values to the variables.

On their own, variables aren't very powerful. The most important thing about them is the way they can make the same command mean different things. If you've got the command **DRAW a,b,c** this obviously draws a line: but where to, and what colour? It all depends on the values of the variables **a**, **b** and **c**. By changing the values of the variables you can make the command draw a line wherever you want, in whatever colour you want – without having to rewrite the line itself.

But what good is all this? Well, remember the silly little program right at the start that printed the same message a hundred times? The program had one **PRINT** command, but the **FOR** and **NEXT** commands told the CPC to perform the **PRINT** a hundred times.

The "hundred messages" program wasn't very exciting, because it did the same thing over and over again. If we used **FOR** and **NEXT** in the same way with our square-drawing program, we'd just keep drawing the same square in the same place over and over again – and that would be very boring indeed.

With variables, however, we've seen that you can make the same command do different things. Instead of drawing the square in the same place over and over, you could move it a little bit each time. Alter your program to read as follows:

```
5 FOR a=0 TO 599
10 CLS:MOVE a,180
20 DRAW a+40,180,1
30 DRAW a+40,220,1
40 DRAW a,180,1
50 DRAW a,180,1
60 NEXT
```

we're looking at two separate commands. The first is **a=300**, and the second is **b=340**. The command **a=300** tells the CPC that from now on whenever you use the letter **a** by itself, you mean the number 300.

This means that the command **MOVE a,180,1** means the same thing to the computer as **MOVE 300,180,1**. Likewise, **DRAW b,220,1** has the same effect as **DRAW 340,220,1**, because **b=340** tells the CPC that you're using **b** to mean the number 340.

Of course **DRAW b,220,1** only means **DRAW 340,220,1** because line 5 says **b=340**. As we've already seen, if you change line 5 to read **5 a=0:b=40** then the CPC will treat **DRAW b,220,1** as being equal to **DRAW 40,220,1**. In other words, you can change the meaning of all the commands which use **a** or **b** as operands, simply by altering line 5.

This saves a lot of effort, but it's not the end of the story. Make sure

line 5 is the original **5 a=300:b=340** and then type in a new line 45 to read:

```
45 a=260
```

Now run the program and see what happens. You should find that the left-hand side of the square doesn't join up, but goes off at an angle instead. This left-hand side is drawn by line 50. List the program, and you'll see that line 50 reads **50 DRAW 300,180,1**. You could do the same for "b" in between lines 20 and 30, if you liked.

...and run it. We'll go through how it works next time, when we round off loops and variables.

## Hackers Only

The box that caters for more advanced programmers.

So you want to print big? Well this routine might just do the trick. It prints – at the cursor position – a character eight times larger than normal – and that's a fact. Supply the B register with the character you wish to enlarge and call the start address. Entry conditions: B holds character to expand. Exit conditions: AF, BC, DE, HL, and IX corrupt. Length: 80 bytes. Code type: position dependent.

```
ORG &8000
CALL &B906          loopb
PUSH AF
LD A,B              SLA C
CALL &BBA5          JR C,finish
LD IX,buffer        LD A,32
LD B,8              CALL &BB5A
                    JR exit
```

```
loop
LD A,(HL)
LD (IX),A
INC HL
INC IX
DJNZ loop
POP AF
CALL &B90C
LD IX,buffer
LD D,8              loopc
                    LD A,8
                    CALL &BB5A
                    DJNZ loopc
                    DEC D
                    JR NZ,loopa
                    RET
                    buff
                    DS 8
```

```
POKE 370,20:POKE 371,21 <return>
```

Listing the program shows a line number of value 5396. What? At first sight this way well seem impossible, but convert each decimal number (20 and 21, that is) to hexadecimal and you get  $14_{16}$  and  $15_{16}$  respectively. Now convert the value 5396 to hex. The answer:  $1514_{16}$ . That's 20 and 21 back to front and side by side. High denomination numbers and addresses are stored in memory in low byte, high byte order. Put simply this means the least significant part of the number comes first and the most significant part second – back to front from normal.

Of course, this can be tricky to verify if the numbers are viewed in decimal. How do you get the 16-bit value 5396 from the 8-biters 20 and 21? A short algorithm (formula) to the rescue. Try...

```
num=5396:POKE 370,num\256:POKE 371,num MOD 256
```

Now list the Basic program. Voila. The line number appears as 5396. Try changing the variable **num** to some other 16-bit value. It works every time.

As it is hard to spot the high byte and low byte relationship when working in decimal, it is best to work in hexadecimal. It is far easier to see that the high byte of the hex number  $3039_{16}$  is  $30_{16}$  and the low byte is  $39_{16}$ . Consider the same number in decimal: 12345. Could you tell straight off that the high byte is 48 and the low byte is 57? No. Work in hex, stay sane.

Next month the big plunge. Your first splash at assembler. But before getting your feet wet, try finding the high and low byte values of the following numbers:  $3654_{10}$ ,  $13107_{10}$ ,  $2307_{16}$ .

# Eurovision Sampling

A new sound-sampler has just crossed the channel. Pat McDonald bends an ear.

## Digivox

EMM, 845 French francs, CPM 2.2 disk only

It may seem sometimes as if the CPC market is cooling down. Not so: for everyone who leaves another joins in the fun. EMM produce some serious hardware for the CPCs in la belle Paris. Their latest is the *Digivox*, a digital sound/voice sampler.

Samplers have been around now for a couple of years. The basic premise of these is that you can record and playback live sounds digitally, rather than using an analogue method such as magnetic tape. The difference being that the digital method stores sounds as a series of numbers.

The main advantage of this is that a computer can read in and handle numbers, and can therefore perform processing and recognition tasks on sounds. An obvious example being the speaking computer. A computer controlling a tape deck could perform a similar task, but it would have difficulty re-recording and altering samples.

Once you have captured a sample, you can alter it in various ways. The most obvious is speeding up or slowing down a sound or voice, and repeating it. In the music business sampling is definitely a major tool in creating songs, simply by re-hashing old material. Messrs Stock, Aitken & Waterman have made a pile of money but haven't exactly made a major contribution to the art of music using these devices.

### Internationale

To receive a *Digivox*, you will need to buy it direct from EMM through mail-order. This is the reason for the price being given in French francs. So you can either send a Euro-cheque or an International Money Order for the amount. Translated into English currency it's about £79. Remember to ask for the English version!

Given the ease and availability of E-c's and IMO's, I am surprised that more foreign companies don't do English version CPC products. I suppose there is a reason, but it must be obscure.

So, how can a humble Amstrad perform in such a high tech area? *Digivox* is a black box that plugs into the back. It is mainly aimed at capturing human speech, although sampling sounds is possible. Supplied is a CPM 2.2 disk, but no instructions. There is a good reason for this, in that the program is very easy to use.

On loading, you are presented with a small, four option menu. To pass from one to the other you use the **RETURN** key, and **SPACE** selects. The options are:

- Retrieve a sample from disk.
- Save a sample to disk.
- Record/Playback a sample.
- Go back to CPM.

Hardly complicated, is it?

To record a sample, (the device has a built in microphone, by the way) simply select the relevant option, go to record and press R. To play back, press P. No processing, slowing down or speeding up is possible with this program.

Up to 16 seconds can be recorded, although recording in blocks of

four seconds is possible. Crude mixing is supported: you can play different samples into different blocks, then play the whole.

On board the device is 32K of RAM. This is backed up with a battery, which means that what is held in memory isn't forgotten when you switch the computer off. All the samples are stored here.

The external memory is split into four separate 8K banks. Each is capable of holding about four seconds worth of sample. The sampling rate is given at 16Kbits per second for the technically minded.

When using the device, the reproduction quality wasn't bad. Imagine listening to the radio, when it isn't quite tuned. That gives you some idea. The demonstration samples were mainly of conversation, with a couple of bursts of music.

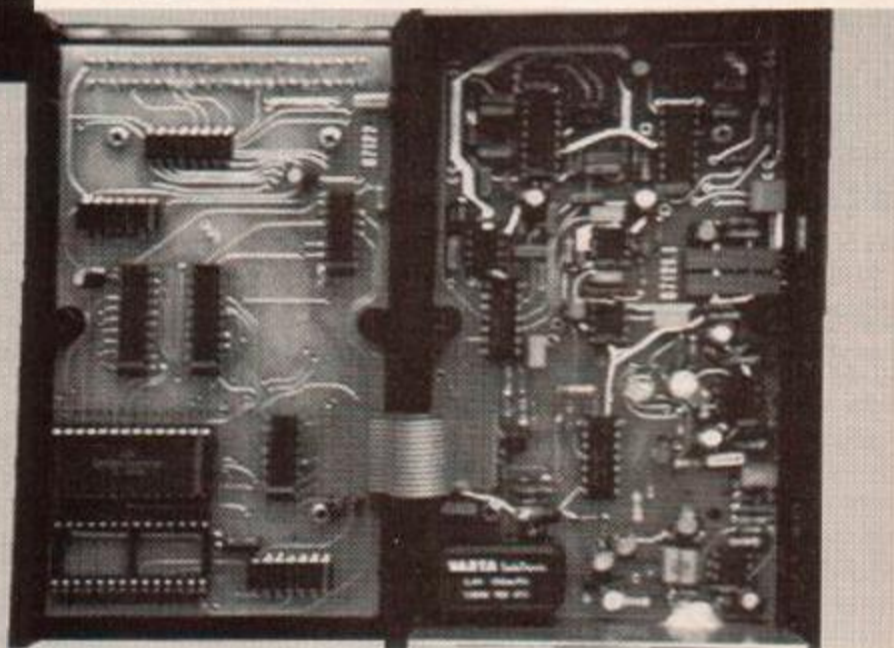

Apparently the device incorporates a sound filter or two, however you still hear a hiss on playback, possibly due to the use of a microphone. A better idea might have been a socket to plug in a microphone - or an external cassette recorder.

So, what's the final word on the package? Well, for a start, the hardware really is very good. Having an external memory bank to store samples in is one solution to the CPC464/664 memory problems. Of course, using CPM 2.2 means that, in effect, every Amstrad user with a disk drive can use the product.

### Sugar & Spice

Opening up the *Digivox* reveals two circuit boards. They are fairly well populated with components, and one includes a chip socket. From this, the average boffin might well work out that something extra is designed to be fitted. What, exactly?

EMM have indicated to us that the extra memory can be expanded to 128K of RAM. This will extend the performance to around a minute of playing time. On top of this they intend to release some software to enable the device to be used as a RAM disk. This is excellent news - imagine having your favourite game saved permanently in the non-volatile memory!

On the minus side, why is CPM 2.2 used at all? Wouldn't it have been better to have used Amsdos? As it stands, the software on the device lets the package down somewhat - no speed adjustments, very rudimentary editing - and a few RSX's for speech recognition would have been nice.

Still, lets wait and see what else EMM come up with.

GOOD NEWS	BAD NEWS
■ Can sample for a reasonable length of time.	■ No UK distributor yet.
■ Good quality on the samples.	■ Software isn't that good.
■ Memory is battery backed up.	■ Expensive.

EMM, 7 rue Melingue, 75019 Paris, France.



## Dataphone ROM

As a follow up to last month's review of the Designer modem, Pat McDonald examines Dataphone's own Interface & Software £45.94, Dataphone, ROM only

If you've bought the *Demon II* modem from Dataphone then you'll appreciate the fact that without relevant driver software it is useless. The manufacturers know about this and have commissioned some software specially for it. This is supplied complete with a KDS RS232 interface.

The problem is that the *Demon II* (and *Voyager 7*, for that matter) use a different method of selecting auto-dial/auto-answer, baud rate settings, etc. This is accomplished by toggling the RTS line up and down. The solution is to write software to use this method.

In fact, what Dataphone have done is to adapt the existing KDS software to run with their modem. So this review is as much about that program as anything else.

### Mac messes up

Last month we reviewed the *Demon II/Designer* modems from Dataphone. Well, I got the prices slightly wrong, I forgot to include V.A.T.

After connecting the interface and powering up the ROM asks you if you want to use it. If not then the interface is paged out and becomes inaccessible, although the RSX's are still initialised.

The software can be used in two different ways. You can either use the menu driven routines to fulfill your needs, or alternatively write your own software using the copious amount of RSX's - 54 to be precise. So the program is suitable for those who wish to use a standard program and also the people who like experimenting & programming.

The ready made comms package is fairly inclusive. It starts off with a main menu. This lists all the obvious services you might use - Prestel/Viewdata, bulletin boards and e-mail. They are all of a similar format, giving you auto-dial/auto-answer options. You can set up protocol as well.

Of more interest is the Phone Directory. The name, telephone number and protocol can be stored on this for each individual service that you dial into. Selection is by means of entering a single character -

it's a good function that will save time. Unfortunately only 18 such entries can be made, but you can save different directories onto disk or tape.

Another function is the text editor. This can be used to store messages when you're offline, thereby saving money. It's not exactly *Protext* but it does the job. All delete presses and such like are stored rather than just deleting characters from the editor.

When you are actually on-line the regular host of features is there to help where it can. These include sending and receiving files using XMODEM, downloading telesoftware, toggling the printer on and off, etc. There is a buffer function which spools to disk, so sessions can be saved for future reference.

A thoughtful inclusion is the graphic codes facility. The Amstrad uses certain codes below ASCII 32 for setting up windows and inks. You can either screen out such characters, have the screen obey them or just print them as those strange symbols you get when you press the control key and a letter.

The manual is rather poorly written, and assumes too much knowledge for a beginner. All the information is there, and after you have learned the keypad functions you probably won't refer to it that much. If you have bought a *Dataphone* modem as well, that manual helps to fill in the gaps somewhat.

Dataphone are now promoting a complete package, consisting of a KDS interface +ROM software and a modem. Everything is included to get your Amstrad on-line. Full details are available from Dataphone.

### GOOD NEWS

- Excellent value for money.
- Lot's of RSX's just for the intrepid.
- Communications options are quite powerful.

### BAD NEWS

- Lacks certain features.
- Manual can put you off at times.

The cost-effectiveness of the package is tempting, and what few omissions there are - no uploading telesoftware, no graphics dump, no carousel - are hardly crucial. Of course, you can always upgrade your system with the *Cage Comms ROM* or *Axis* from Monflair.

Dataphone ☎ 0733 230240, 22 Alfric Square, Woodston, Peterborough PE2 0JP

## Multiface II+

Romantic have developed an improved version, of the mark two, of the updated - an investigation of the latest *Multiface* by Pat McDonald. Romantic Robot, £42.88

Definitely one of the prominent supporters of the CPC, Romantic Robot have been producing *Multiface* for some time. Various updates have been introduced, and the II version was reviewed in AA32. What have they done now?

The idea behind this type of product is that they are plugged into the user port, and quietly sit there while you load in some software. When you press a button on the device it takes control away from the internal program. The main use of this is that you can load in a tape game, interrupt it and save it back out to disk.

But people could abuse this concept by then making pirate copies of the disk. *Multiface* has been proofed against this, because it must be pre-

sent in order to load software back in.

Anyway, some software companies still were not keen on the idea, and incorporated various routines in games to search for the *Multiface* if it was plugged in. If one was detected then the game wouldn't load in the first place.

So Romantic Robot stuck a switch on it. When the switch was up (off), it was invisible to software. When down (on), the *Multiface* could be used normally. The trouble was that the switches soon wore out.

Now we have the final version. The switch has been removed, and instead the on/off function has been transferred to the button. The upshot of all this is that the *Multiface II+* is only visible to games software when it's active. By then it's too late for the software to do anything about it.

The device also features a reset button. This will reset your Amstrad no matter what. It can also be used to switch on the *Multiface* but doing so will leave the Amstrad's program alone. For a very good reason: you need to do this to load a game back in.

### GOOD NEWS

- Now even better.
- Easier to use.
- No price increase.

### BAD NEWS

- Still no dis-assemble function.

Romantic Robot ☎ 01 200 8870, 54 Deanscroft Ave, London NW9 8EN

### Hackit

Also reviewed in AA32 was an interesting device called *Hackit* from Siren Software. This lacked some of the possibilities for tape-disk backup but had a dis-assembler program built in. As implied in the name, the whole was billed as a hacking device for discovering pokes etc and was aimed at the more technical user.

# K&M COMPUTERS

THE LEADING AMSTRAD MAIL ORDER SPECIALISTS

\* THE CHEAPEST \* FRIENDLIEST \* SERVICE AVAILABLE \*

*ADVENTURE*		*ARCADE*		*ACCESSORIES*	
Cass	Disc	Cass	Disc	Cass	Disc
Time and Magic	£10.70	Platoon	£6.70	Amsoft 3" Disks	
The Pawn 6128 Only	£14.45	Gunsplode	£6.70	£22.95 for 10, each	£2.50
Gold of Thieves (6128)	£14.45	Rolling Thunder	£6.70	Rombox Rombox	£34.95
Hollywood Hijinx	£20.95	Target Renegade	£6.30	DMP 2160 Printer (Phone)	£159.95
Lurking Horror	£20.95	N. Mansells G. Prix	£7.70	Cover Set 464/6128 cool/green	£6.95
Stationall	£19.00	Venom Strikes Back	£6.70	Cover Set DMP 2000	
Silicon Dreams	£10.70	Sidarms	£6.70	2150/3160	£4.50
Jewels of Darkness	£14.45	Predator	£5.99	Multiface II	£44.95
Jinxer (6128)	£14.45	Vixen	£7.70	MP2 Modulator (Phone)	£28.95
Knight Orc CPC/PCW	£10.70	Elite	£6.70	DMP 2000/3000 Printer Rib	£3.99
Pirates (6128)	£14.45	Starglider	£10.70	Lockable 3" Disc boxes (48)	£9.99
		Bob Winner	£6.70	MousMats	£4.95
		Bedlam	£6.70		
		Alternative W Games	£6.70		
		The Dark Side	£6.70		
		Druid 2	£6.30		
		Impossible Mission II	£6.70		
		Shackled	£6.70		
		Bubble Bobble	£6.30		
		Rimrunner	£6.70		
		Northstar	£6.70		
		Guantlet II	£6.70		
		Vampires Empire	£6.70		
		Outrun	£6.70		
		Corporation	£6.70		
		Bravestarr	£6.70		
		Lazer Tag	£6.70		
		Pink Panther	£6.70		
		Victory Road	£6.30		
		Dan Dare II	£6.30		
		Gothic	£6.30		
		Tetric	£6.30		
		Wizard Warz	£6.70		
		Karnov	£6.70		
		September	£6.70		
		Cyberoid	£6.70		
		Arkanioid II	£6.30		
		Gryzor	£6.30		
		Black Lamp	£6.30		
		Get Dexter II	£6.70		
		Nimbus	£6.70		

All RSD connections products available at discount prices, cables, leads, plugs, sockets, spike protectors etc. All software in this advert should be available now. Please phone to confirm new releases. We have over 75 titles on special offer, Cassettes from £1.75, Discs from £2.99, Phone or write for details. \* If you see anyone advertising software at a lower price than us, we will match that price (except special offers). \* All prices include post and packing. In stock items sent by return. All budget titles stocked £1.80 & £2.75. \* We also have an extensive range of C.P.C software for Hire-free membership-send for details. \* Cash with order or send for full lists. \* Overseas orders welcome. \* Please add £1 per item for overseas postage. \* British postal orders or sterling cheques. \* Return of post service. \* All new releases on day of release.

**\*K & M COMPUTERS, 40 FAIRSTEAD, BIRCH GREEN, SKELMERSDALE, LANCS, WN8 6RD\* 24 HRS PHONE 0695 29046**

## DEMON DEVELOPMENT CARTRIDGE

The Ultimate machine code tool. Suitable for 464/664 and 6128 machines. Demon will give you full control of your Amstrad. Stop Any program Anytime by a press of a button, the memory remains intact and can be saved to Tape/Disc, debugged, traced, moved, disassembled etc. Inline Z80 assembler, Bank switching for 6128 machines etc etc. More functions than ANY other unit of this type on the market. Demon Cartridge with user manual only £24.95. (note no through connector).

### EPROM PROGRAMMER

Transfer your favourite programs onto Eprom. Suitable for 464/664 and 6128 machines. \* Programs 2764 and 27128 type Eproms. \* Switchable for 12.5 or 21 volt types. \* Normal or Fast algorithm programming. \* Powerful but easy to use software. \* Rom to Rom copy, Editing, Verification. Single or block programming. \* Full screen Editing for BIN files. \* Completely self-contained in smart impact resistant case. (no messy separate power supply) \* 12 months parts & labour guarantee. Eprom Programmer, Software & 12 months guarantee Only £39.95. Available in kit form with through edge connector (uncased) £31.25. Blank 16k Eproms available phone for latest prices.

### EPROM EXPANSION BOARD

Holds 4 Eproms. Suitable for Maxam, Protex, Utopia etc etc. Top Quality silk screen printed PCB measures 7cm x 12cm approx with through edge connector to allow the use of disc (464) or other peripherals. Complete kit of parts with instructions to build it yourself £16.75. Ready built and tested only £21.95.

### CP/M PD SOFTWARE SUPPLIED ON CF2 DISCS

CPM DISC A	Machine code Tools	£5.50
	Contains Z80 and 8080 Assemblers, Z80 to 8080 to Z80 code translator. Debug monitor. Disassembler, Bin file compiler, plus NewSweep disc maintenance utility which replaces over 100k of CPM utilities.	
CPM DISC B	Computer Languages	£5.50
	C: Compiler produces machine code, includes floating point routines. LISP, PROLOG, Small C Interpreter. EBASIC. Full blown Compiler Basic with floating point, SIN, COS, TAN, etc. All these plus NewSweep as disc 'A'	
CPM DISC C/D	Pascal plus (two disc set)	£10.00
	JRT Pascal v3.0 with extensive manual on disc. Full blown Pascal compiler with floating point, sequential and random disc files. Arctan, Cos, Exp, Sin etc. COBOL compiler with manual and examples. Discs also contain a powerful Text editor for general use. Small C, Ebasic and Newsweep.	
CPM DISC E	File and Disc Management	£5.50
	Contains many useful programs. Edit disc sectors, sort text files, Word counter, Disc quality checker, PCW disc reader plus NewSweep etc, etc.	
CPM DISC F	Fun and Games	£5.50
	Chess, Cave adventure, Othello, Word search, Golf, Maze generator plus Comms utility, Prolog, Biorhythms, Onscreen calc, NewSweep etc, etc.	
CPM DISC G	Business programs	£5.50
	Scrivener spreadsheet, inventory database, Spelling checker, sorter, word counter. Powerful Text editor, Comms utility plus NewSweep.	

Many other items in stock including PCB designer & PC1512 software send SAE  
**JOHN MORRISON (AA)**  
4 REIN GARDENS, TINGLEY, WEST YORKSHIRE,  
WF3 1JR. TELEPHONE (0532) 537 507  
Return of post service on Access or P.Os.  
Please allow 3 days for cheques

## NEMESIS THE ORIGINAL MEDDLERS

### BONZO SUPER MEDDLER (FOR ANY CPC)

THE dedicated TAPE TO DISC utility includes the devastating **BONZO'S HACK PACK**

BONZO SUPER MEDDLER is GUARANTEED TO TRANSFER MORE GAMES THAN ANY OTHER PROGRAM: THE FIRST PERSON TO FIND A MORE SUCCESSFUL PROGRAM WILL RECEIVE TREBLE THEIR MONEY BACK!! BONZO uses LESS memory, transfers MORE, COSTS LESS and gives REAL support to the user.

### THE 1988 VERSION

Clearly the best in 1987, BSM & HACKPACK began 1988 with up to the minute refinements, **NOW EVEN MORE VERSATILE**. Return your old BSM DISC with £3 for a full upgrade.

\*\* Details of **OVER 650 TRANSFERS** supplied. \*\*

Other advertisers will tell you little gems about their utility handling AMSDOS filenames correctly, BONZO does too - big deal! Here's something more interesting, 50 out of the 650+ that transfer with the latest **BONZO SUPER MEDDLER**.

AVENGER, ANARCHY, ANTIPIAD, ARKANOID, ARMY MOVES 1&2, BARBARIAN BACK TO THE FUTURE, CAULDRON 1 & 2, COMBAT ZONE, CHP, BASKETBALL, COPOUT, DRILLER, EQUINOX, ENDURO RACER, FOOTBALLER OF THE YEAR, FROSTBYTE, GRAND PRIX SIMULATOR, GOONIES, HARVEY HEADBANGER, HERBERT'S DUMMY RUN, INTERNATIONAL KARATE +, JACK THE NIPPER, KNIGHTMARE, KILLAPEDE, LIVING DAYLIGHTS, LEADERBOARD, MICROBALL, MOLECULEMAN, METALYX, NEXOR, OBSIDIAN, PRO SNOOKER SIMULATOR, QUARTET, QUESTOR, REFLEX, SKATEROCK SIMULATOR, SUPERSPRINT, SIDEWALK, STARRAIDERS II, SOUTHERNE BELLE, STARWARS, SPACEACE, SPINDIZZY, SCRABBLE, TETRIS, THRUST 1&2, ULTIMA RATIO, VAMPIRE, WONDERBOY, XOR, ZUB, ZOIDS, 3D GRAND PRIX, DARTS 180, 2112AD.

Check these against your existing utility. **'NUFF SAID!'**

**BSM & HACKPACK DISC £12.50 - Only**

**NEMESIS (AA)**  
10 Carlow Road, Ringstead  
Kettering, Northants NN14 4DW  
Tel: (0933) 623967

### BONZO'S DOO - DAH

"This is the best I've seen in a long while..... I recommend it"  
- AMSTRAD ACTION, JUNE 1987.

**FEATURES BIGBONZO FORMAT**  
A REALLY USABLE 203K PER SIDE FORMAT, with all the support files to maximise it's use. **PLUS** - All the disc housekeeping features that you could possibly want, including "Cloning", Directory & Sector edit, Disc search, Formatting, Read sectors, Filecopy, etc. ALL FUNCTIONS are effective on normal, enhanced, and the vast majority of "funny formats".

**MANY UNIQUE FEATURES. Supplied on DISC - £12.50**

### BONZO BLITZ - NEW SPEEDLOCK'S to DISC!!

A TOTAL utility for SPEEDLOCKS, straight to DISC from TAPE!

### ABSOLUTELY NO "JUGGLING" -

"HIGHLY RECOMMENDED", WACCI, 12/87.

### WHAT CAN IT DO?

There's not many that it can't do! BLITZ works on a standard 464 as well as the 6128 & expanded machines. All our claims are based on user reports. A small selection for flavour!  
GAMEOVER, SLAPFIGHT, MAG MAX, MARIO BROS., ARMAGEDDON MAN, ARMY MOVES, F15 STRIKE, GREAT ESCAPE, BLACK MAGIC, WARLOCK, SPACE SHUTTLE, METRO-CROSS, DIZZY, TRANSMUTERS, SHAO LINS RD, ARKANOID, COBRA STALLONE, DALEY'S SUPERTEST, TOP GUN, MIKIE, SCALEXTRIC, SARACEN, SHORT CIRCUIT, EXPRESS RAIDER, XEVIOUS, TOURNAMENT LEADERBOARD, SCRABBLE, FREDDY HARDEST 1&2, MADBALL, MATCHDAY II, PHANTOM CLUB, SUPER HANG ON, DAN DARE II, etc.  
Return your old BLITZ disc with £3.00 for full upgrade.

**DISC ONLY - Just £12.50 inc**

### MORE BONZO GOODIES

#### BONZO'S FLASHPACK

"BEST ALL ROUND BASIC EXTENSION PROGRAM SEEN". WACCI 3/1988  
A STUNNING ENHANCEMENT TO "LOCO" BASIC **DISC. £12.50**

#### BONZO'S BIG BATCH

A VERSATILE DATABASE, A POOLS PREDICTOR, AND A MODE 0 SPRITE/SCREEN DESIGNER. **DISC. £12.50**

ALL WITH FULL INSTRUCTIONS & AFTER SALES SUPPORT  
ORDERS by CHEQUE, P.O's ACCESS, sent by return.  
(OVERSEAS please add £1.50 to total)

# Soldering On

Simon Watson has sent in a great project for all those joystick junkies who hate hammering away at the fire-button.

Many of the joysticks currently on the market sport an "autofire" option, relieving you of repeatedly pressing the fire button. Unfortunately these built-in devices don't work on Amstrad CPC's. Now you can build your own that will work.

This simple device provides a similar function. I have no idea how similar my circuit is to commercial types, but my circuit allows you to adjust the rate of fire. It also gives a visual indication when it is working.

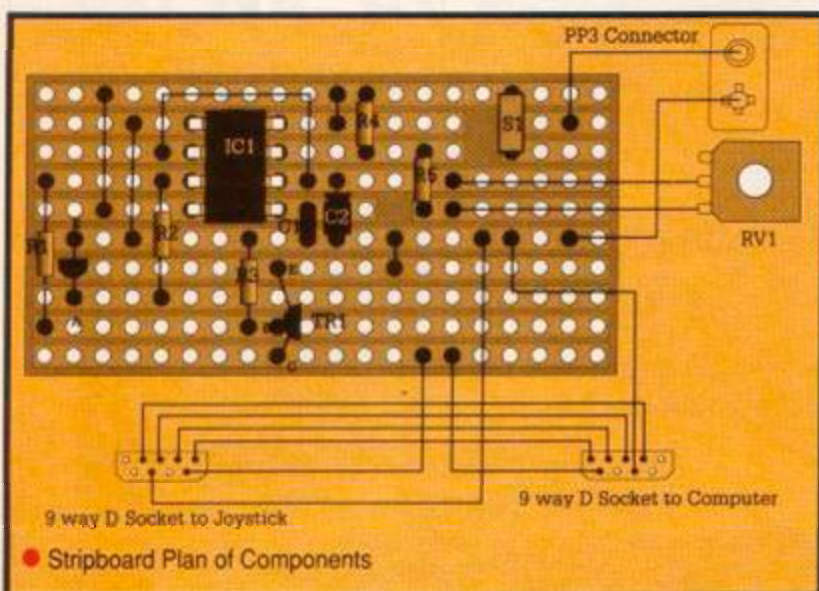

When completed, the circuit plugs into the computer and the joystick into the circuit. Power is provided by a PP3 battery (not included!) but as the power consumption is small it should last for a good few hours – get a rechargeable battery and a charger for most economical use.

Best of all – the price for blasting entire fleets of aliens and saving the earth single-handed is around £3 if you already have some wire. The complete list of components costs £4.22 plus £1 postage and packing.

## Resistor Colour Codes

Although the five resistors may look identical they all in fact have different values. The secret to which lies in their coloured bands. Read an electronics book if you really want to know why each colour code corresponds to a particular value: otherwise refer to the chart below. And ignore the silver or gold band, which indicates the accuracy of the device.

R1	– 2.2K	– Red/Red/Red
R2	– 680 Ohm	– Blue/Grey/Brown
R3	– 4.7K	– Yellow/Violet/Red
R4	– 10K	– Brown/Black/Orange
R5	– 15K	– Brown/Green/Orange

The components are widely available although the prices and order codes quoted are from Maplin Electronics. You can buy a catalogue of their products from major newsagents.

## Construction

Begin by cutting the tracks at the positions shown on the bottom strip-board plan. This is best done by twisting a small drill bit at the desired location until the copper is worn through.

Before soldering anything, make sure you can identify each of the components. Then slowly work across the board, inserting a component, checking its orientation and then soldering it. Do not try to solder the integrated circuit chip as this may result in damage. Instead, solder the DIL socket in its place and then insert the IC into this.

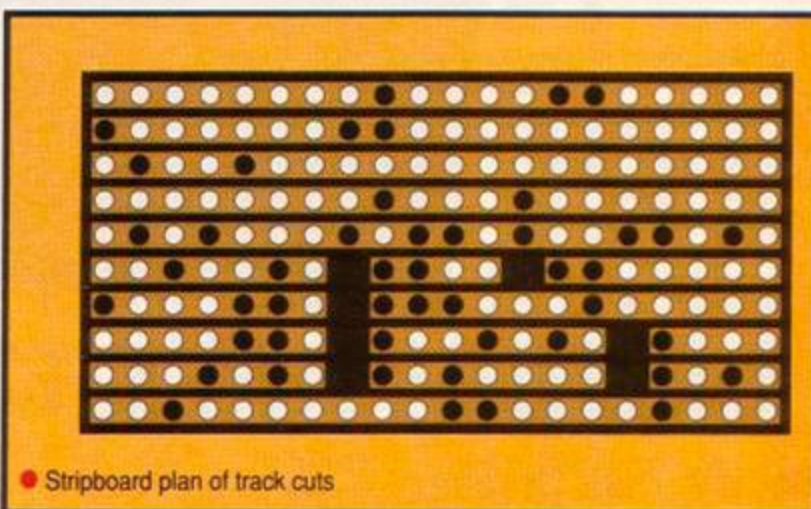

If the tags on the switch do not fit through the holes on the strip-board, then solder some wire between the holes and the tags – and take care not to mix up the D plug and the D socket.

Once all the components have been connected push a PP3 battery into the clip, insert the D socket into the computer's joystick port, insert your joystick into the D plug and switch the computer and circuit on. A trail of X's (fire commands) should start to appear on the screen and the LED should pulse. If they do not or you wish to change the speed, adjust RV1. With some practice you should easily be able to obtain the desired speed for each of your games.

## Any more?

If you have any projects that are suitable for this column, then send them in. Make sure they're marked "Hardware Projects". We generally prefer small, easy to build (and cheap!) designs but we consider everything we get.

## List of Components

Abbrev.	Name	Maplin's Order Code	Connecting Holes
R1	2.2K Resistor	M2K2	A4, A9
R2	680 Ohm Resistor	M680R	E4, E8
R3	4.7K Resistor	M4K7	H6, H9
R4	10K Resistor	M10K	L1, L3
R5	15K Resistor	M15K	N3, N5
RV1	Pot Log 100K	FW25C	O4, O5
C1	0.01 uF Disc Cap	YR736	J5, J6
C2	1 uF Electrolytic Cap	FB12N	K4, K6
TR1	BC548 NPN Transistor	QB73Q	I7, I9, I10
DIL Skt	8-Pin DIL Socket	BL17T	
F1, F5, I1, I5			
IC1	NE555V Timer Chip	QB66W	into DIL
LED	5mm Red LED	WL27E	B6, B8
S1	SPST Slide Switch	FF77J	Q1, Q2, Q3
PP3 Clip	PP3 Battery Connector	HF28F	S2, S6
9W D-Skt	D Submin 9 Way Socket	RK61R	Q6, P6
9W D-Plug	D Submin 9 Way Plug	RK60Q	O10, N10
Wire	Solid Core Wire	BL95D	Various!
Stripboard	0.1 Inch Stripboard	FL06G	–

For "pot" read potentiometer, for "cap" read capacitor.

Contact: Maplin Electronics Ltd, PO Box 3, Rayleigh, Essex, SS6 8LR  
☎ 0702 554 155.

## Component Orientation

- 1] The LED has two leads – the anode and the cathode. They are indicated on the stripboard plan as "a" and "k" and must be connected accordingly.
- 2] The transistor has three legs: emitter, base and collector. Differ from the stripboard plan and you'll probably ruin it.
- 3] The IC has a small notch at one end. Again, check with the stripboard plan as to which way it goes.
- 4] The electrolytic capacitor has two different ends. The band marks the -VE lead, the groove indicates the +VE. Make sure they match the diagram.
- 5] The potentiometer only needs to be soldered at the centre and right tags. Orientation does not matter in this case.
- The PP3 clip has two wires, one red, the other black. Connect these wrong and dire consequences will result...

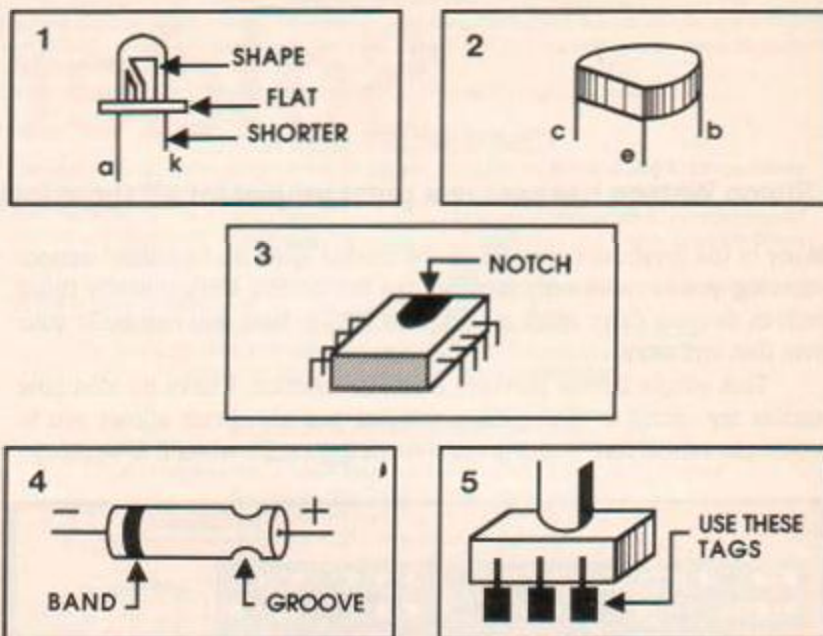

# Little Acorns

There are a growing number of products that are produced by small one person firms and available on mail-order only. Pat McDonald checks out if these homebrews are any good.

## Educational: Spell Tutor

**K R Cranswick** saw a distinct lack of good, cheap educational software. So he decided to create some to help his children learn to read and write.

The main program puts a word on the screen, letter by letter. The idea is to type the letter on the keyboard: when this has been completed it prints the next letter. All the letters are drawn slowly in the manner that you would write them. And you can easily alter which words are used by the program.

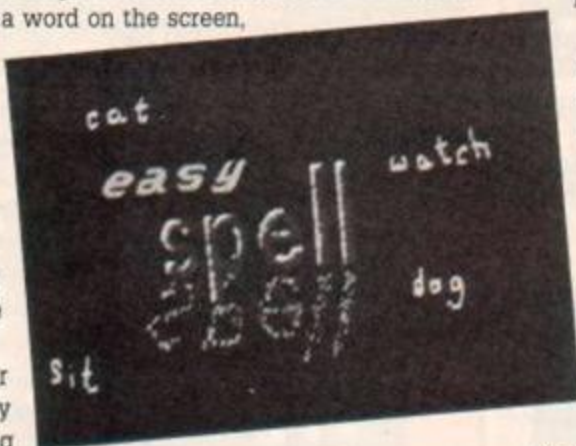

It is supplied on disk for £5 or tape for £3. If you supply the medium then the copying charge is only £2. Disk users also receive an additional, simpler program. This draws a much larger, single letter using the whole screen.

At the price, these are a good buy.

## Utility: Disk Cracker

**Tristan McDonald** (no relation) sells a disk utility. There are already a number of similar products on the market, so what's the big deal?

For a start this one costs just £6.99. Some of the features it supports are a directory/sector editor, a disk mapper to say which file is where on the disk, a fast format option and many others.

Naturally, disk copying is supported. But at least the adequate documentation does state that this must not be used to infringe copyright. It is a fairly powerful device, although because the program will work on smaller memory CPCs a lot of disk swapping is necessary.

One novel feature is the inclusion of a program to set up your own disk formats. Reference to outside documentation should be made (AA18 – AA20), but the program itself is fairly easy to use.

All in all, a bargain.

## Game: Find a Word

**Steve's Services** have produced a word-search program – you know, one of those puzzles where you are presented with a jumble of letters and have to find hidden words.

In use, it is easy to design layouts and print them out. Grid size is 20x20. Random letters can be easily filled into the design when you have finished, although you must check them: the computer is too stupid to recognise an accidental obscenity.

After you have created your masterpiece you can play on the computer, although personally I prefer doing them on paper. The price is a bit steep, £7.95 on disk and £5.95 for tape. Especially considering the poorly written manual.

## Business: Data Master, Kirk Editor and Printcat

The **Rev Alan Sharp** adds to his youth fund raising efforts by writing & selling software. At the moment he bundles a database, a word-processor, plus a disk catalogue printout program on disk for £10. Sounds good? It is!

The database program only works on the 6128, because it stores data in the extra 64K of memory. This means it works very fast but has a limited capacity – a maximum of 2000 records, each record having up to 99 fields. Actual record format is completely up to you, giving this a certain flexibility.

You can search through the database using logical operators: less than, equal to, greater than or not equal to. It can also search for embedded strings or NOT embedded strings. Overall this is a good program for learning about databases.

The word-processor is really an overgrown line editor. You can't deal with individual characters but must use whole lines. Still, it is fast – faster than *Tasword*, with which it shares a few key combinations. It is a nice introduction to the subject but I dare say you will soon want to upgrade.

Overall, **Rev Sharp** has done an excellent job on producing some good quality, low cost software. Who knows, maybe there's more to come.

## Contacts

**K R Cranswick**, JHQ ENG, 11 S.U. Det, RAF Rheindahlen, BFPO 40  
**Tristan McDonald**, 46 Saywell Road, Luton, Bedfordshire, LU2 0QF  
**Steve's Services**, 40 Finmere, Bracknell, Berks, RG12 4WF  
**Rev Alan Sharp**, 73 Manor Avenue, Aberdeen, AB2 7UT

# Now YOU can SAVE...

New  
**LOWER PRICES**

FOR USE WITH  
A · M · S · T · R · A · D  
CPC 6128  
PCW 8256  
PCW 8512 (A & B Drives)  
PCW 9512  
S · P · E · C · T · R · U · M  
ZX Plus 3



**Compumart...**

A GREAT DEAL MORE  
FOR A GOOD DEAL LESS!

- ▲ New LOWER PRICES!!!
- ▲ FREE - 1st Class Delivery
- ▲ FAST, Efficient Service
- ▲ Genuine AMSOFT 3" CF2 Disks
- ▲ Large Stocks - GUARANTEED DELIVERY
- ▲ Unbeatable NO-QUIBBLE GUARANTEES
- ▲ SAME DAY Despatch
- ▲ Individually Cased

# MORE than Just Data!

**Guarantee**  
All our Disks have a full Lifetime Warranty and are individually certified 100% Error Free. Should any disk fail due to a manufacturing error, Compumart will offer either a 2 FOR 1 SWAP or a NO-QUIBBLE FULL REFUND!



All goods usually despatched SAME DAY, by 1st Class Post - FREE OF CHARGE!

We welcome official written orders from PLC's, Government and Educational Establishments etc.

Overseas orders:- Please contact us for Shipping and Insurance charges. Prices/Delivery only apply to U.K. Mainland, N. Ireland and B.F.P.O.'s.

All Prices/Delivery subject to availability, E. & O.E.

VISA

Access

**24 HOUR ORDER LINE**  
telephone  
**0509 610444**

**Compumart**

Dept. AMA  
Jubilee Drive  
Loughborough  
Leics. LE11 0XS  
Tel: 0509-610444  
Fax: 0509-610235

**AMSOFT**  
BOX OF 5 DISKS      BOX OF 10 DISKS  
**£10.39**      **£19.99**  
EX. VAT      EX. VAT  
[£11.95 inc. VAT]      [£22.99 inc. VAT]  
**CF2 Microdisks**

*Don't Forget* We also supply a wide range of Amstrad Peripherals at Super Low Prices - PHONE NOW!!!

**Y O U R O R D E R F O R M**

For IMMEDIATE RESPONSE, simply phone and order with your Credit Card OR send this coupon (with your Cheque/P.O.) to: **COMPUMART, FREEPOST, LOUGHBOROUGH, LE11 0BR.**

Please rush me:-

No. Reqd.	Goods Description	AMOUNT
	Box(es)-5 Blank Disks @ £11.95 ea.	£
	Box(es)-10 Blank Disks @ £22.99 ea.	£
AMA TOTAL		£

Please deliver to:-

Name \_\_\_\_\_

Address \_\_\_\_\_

Postcode \_\_\_\_\_ Date \_\_\_\_\_

**POST FREE**

# Bar CPM

From freebies to fully-priced, Richard Monteiro gets to grips with the delights of CPM software

```
70 CAT:INPUT"ENTER INPUT FILE-
NAME ";fs$
80 OPENIN fs$:INPUT"NUMBER OF
STRINGS ";st%
90 INPUT"ENTER OUTPUT FILENAME
";of$:OPENOUT of$
100 FOR t=1 TO st%:LINE
INPUT#9,a$
110 IF EOF GOTO 140 ELSE PRINT
#9,a$:NEXT
120 CLOSEOUT:INPUT"ENTER NEXT
```

Last issue sparked a shower of response in the form of hints and tips so, to drain the office, that's almost all you will get this month. But first a few notes to wrap up last month's article on reading PCW disks.

Running the READPCW program a few times is all very well, but having to do so every time you wish to read or write PCW disks can become a drag – and you may need to use drive B or the B> prompt for other things. If you haven't any use for the B> prompt, and you intend using PCW disks, it's best to make READPCW automatically run when you boot CPM.

Use a word-processor to create an Ascii file containing the following:

```
B:
READPCW
A:
```



Save

this to your CPM boot disk as

PROFILE.SUB. From now on READPCW will automatically run (providing SUBMIT.COM is also on disk). When a message appears asking you to swap disks, just press return.

Of course, it is possible to transfer all the files from a PCW disk to a CPC-formatted disk. Enter READPCW at the B> and use PIP to copy from B> to A>:

```
PIP B:=A: filename
```

If you have a one-drive system, insert the PCW-format disk when requested for the disk meant for drive B. Similarly, insert the disk you wish to copy the files to when requested for the disk meant for drive A.

## Newsweep pips

Richard Muirhead from York has supplied a listing for converting large Ascii files into several smaller files. Many PD documentation files are formatted in an untidy way and, as such, can't be printed neatly using Newsweep, TYPE or PIP. The answer is to edit the files. However, many are too large to fit into standard word-processors. Thus the listing. Follow the instructions:

• If file needs un-squeezing, do so with Newsweep. If the resulting Ascii file will not fit in your word-processor proceed to the next step.

• Break the file into smaller units using the Basic listing.

```
10 MODE 2:PRINT "ASCII FILE BREAKER":PRINT
20 PRINT"NB: output file must not be present on disk"
30 PRINT" disk space must be greater than source file"
40 PRINT" files over 80k require two drives"
50 PRINT" number determines file length"
60 PRINT" if strings=200 then file size approx 9k"
```

```
FILENAME ";of$:OPENOUT of$
130 GOTO 100
140 CLOSEIN:CLOSEOUT:PRINT:PRINT"ALL DONE!"
```

• Edit resulting files using your word-processor.

• Print the files as they are or reassemble into one text file using PIP B:filename=A:file1,A:file2, etc. The edited file can be printed using TYPE B:filename <control P> <return>, PIP LST:=B:filename or via Newsweep.

While on the subject of Newsweep, Cormac McGaughey from Cushendall in Co Antrim has discovered that the documentation for the program is incorrect. Newsweep offers an option to search all USER areas. The documentation states that the wildcard command for doing this is of the format \*.\*. For instance, A>nswp A:\*.\* <return>.

Do this and the computer stares at you. The actual command is A\*:\*.\*. So things like A>nswp B\*:\*.\* and A>nswp A\*:\*.\*.DQC are acceptable.

## Where to go

If you want to get hold of public domain software, there are several sources which may be of interest:

- Advantage** ☎ 0242 224340  
West One House, St Georges Rd, Cheltenham, GL50 3DT
- CPM User Group**  
72 Mill Road, Hawley, Dartford, Kent, DA2 7RZ
- PD Software** ☎ 08926 63298  
Winscombe House, Beacon Road, Crowborough, East Sussex, TN6 1UL
- Triple Zero Services**  
23 broad Lane, Essington, Nr Wolverhampton, Staffordshire, WV11 2RG
- PD-SIG**  
90 Braybourne Close, Uxbridge, Middlesex, UB8 1UJ

Most of these firms publish a newsletter and have vast software libraries – not all will be of interest to you. There is usually a subscription and copying fee for each disk. Do remember to enclose an SAE when enquiring.

User clubs are also a good place for getting public domain. Wacii (01 898 1090) in particular have a selection of disks crammed with stuff. Well worth checking.

The United Amstrad User Group offer free PD software to club members – free PD software? But surely it's free anyway? Yes, but most libraries charge a handling fee. To enroll as a UAUG member you must send £5 to 1 Magnolia Close, Fareham, Hants, PO14 1PX. For this you get a bi-monthly magazine and access to 2 megabytes of PD software. Enquiries on 0329 281324.

If you have a modem, you can download software from bulletin boards. Try 0462 700644 at any time.

Before you order disks and disks full of PD software, you might like to try getting your hands on *The Free Software Handbook*. This book published by PeopleTalk Associates covers the best public domain software available. It is updated every year. Its ISSN number is 0742-048X.

We shall continue to update this list, so if you know of any worthwhile libraries, bulletin boards, or user clubs do get in touch.

# Comming On-line

Pat McDonald starts a new feature delving into modems, bulletin boards and viewdata.

Comms for the CPC have never been brighter. It seems that more and more people are looking at the subject as a necessary part of their lives, rather than a freakish hobby. As the number of users increases, so do the services available. We begin this month with a very brief look around a couple of services.

## The name game

As you might be aware, some bulletin boards and other services actually encourage the use of pseudonyms. At the same time, more serious boards insist on proper names. Which is in the right? Surely the question of behaviour is wider than this: what is amusing and what isn't is the sort of question that nobody has had the time for before.

As we speak, the *Data Protection Act* is finally settling down. Some boards are being registered as clubs, some aren't bothering for a while. As I write a few MP's are calling for the obscene publications act to cover on-line services. *Corrupt Computing* and similar boards which contain controversial material have received a lot of media coverage lately. It is a certainty that 1988 will prove a watershed for many different comms subjects.

## Leconfield

(0964 550745), 300/300 or 1200/75, 8 Data bits, no parity, 1 stop bit.

*Leconfield CPM and 80 Bus Board* is the full name of this very useful service. As you might have guessed it's a CPM based remote system. Disk users will appreciate CPM, but to all those tape users it's like having a collection of programs listed on a menu. You can run each one individually for different end results.

Does anyone remember the Nascom/Gemini 80 bus board? This was the sort of business micro just being displaced by the Sirius and Apricot back in 1981. Some of the features it boasted were identical to the CPC, but cost a packet more.

Logging-on to the system is simple enough, and you can select your own password. However access time is limited to 30 minutes for a new member until verified. The membership is cleared out every month, so it will pay to regularly log-on and join in.

The bulletin board and message area are of a high standard, and throughout use a series of prompts guides you along. When you get more accustomed to what happens next you can select a terser style, which will save time and hopefully money.

Undoubtedly the main reason why people join *Leconfield* is for the weight of public domain software available for download. Downloading

## The age of the packet switch

This is the age of interactive computing. *Comming On-line* is designed specially for the Comms enthusiast. I know how much you like chatting, so how about some mail? You know, problems, answers, new boards, observations, criticism - we need them all. If it's CPC orientated then get it moving fast towards: *Comming On-line*, Amstrad Action, 4 Queen St, Bath BA1 1EJ.

(and uploading!) is accomplished using XMODEM file transfer - Ward Christensen style. I spooled the directory of new files, ie less than two months old: there were 150. Not all usable by the CPC, and not all for CPM even - there's a thriving PC section. Okay, now for the bad news - you don't get access to the software at first. Apparently far too many people were dialling up and logging on under many different names, downloading everything in sight. The service suffered as a result. So now we the responsible majority have the task of convincing the sysop to please let us download some software.

So the system is, as it were, on parole. Please don't make things worse by foolish or belligerent behaviour. Just behave in a normal, adult fashion, log on using your real name and things might get better.

## Gnome at home

(01 888 8894), 7 data bits, no parity, one stop bit, Viewdata

The *Gnome* is one of the stranger services available. Logging on is easy enough, although you must terminate your name with &5F ASCII, or "\_". Having a viewdata element means the whole look and feel of a board are changed.

Of interest to AA readers is the existence of a small area devoted to WACCI, the worldwide Amstrad CPC users club. Admittedly there isn't an awful lot to see, although it's nice to see the Amstrad getting niches here and there.

There are other SIGs (Special Interest Groups) mainly orientated around lesser computers. Occasionally parts of the board disappear and gateways become duplicated, which can be disconcerting. Another extremely embarrassing problem I have is that I can't find the log-off facilities. Sorry, *Gnome*, I need therapy.

Labyrinthe also has a substantial area devoted to it. This has the dubious distinction of being a live action role-playing game. You too can sally forth and beat the legions of hell into a bloody pulp with a plastic sabre. All good stuff. I believe that smaller audience areas like this are fascinating to read about.

Telesoftware is covered to a certain extent, and a balance has been struck between the programming/computer groups and the other sections. The whole board is really geared to offering coverage to a wide range of minority interests.

There are plenty of other hidden grottoes devoted to this or that subject, and the *Gnome* is well worth a browsing visit at off-peak times. If you think this coverage is shallow, you're dead right. Don't just read about it, pay the *Gnome* a visit!



**DATAPHONE** THE MODEM PEOPLE

THE *Designer* MODEM  
A BABT APPROVED V21/V23  
AUTO-MANUAL MODEM





**DEMON** □  
A BABT APPROVED V21/V23  
AUTO MODEM

FOR CONTENTS SEE SIDE PANEL

# HOT TIPS

Do you have special tricks and tactics with serious software and hardware? Send them to Pat McDonald, "Hot Tips", Amstrad Action, 4 Queen Street, Bath, BA1 1EJ. Remember the best tip each month gets £20.

## Flashing lights

I have found two commands of use to disk owners. The first two start and stop the disk drive motor. They are:

OUT &F000, 1 to turn it on.

OUT &F000, 0 to turn it off.

The second can turn the disk light on or off.

OUT &E91B, number from 0-255.

An example program:

10 OUT &F000, 1

20 OUT &E91B, INT (RND\*255)

30 GOTO 20  
Mark Wood, Halifax

## One liner

While using Mark Rowbottoms database which was on the Christmas cover tape, I decided I didn't like the "Search File" facility. Rather than finding an exact match, the line below will enable the program to scan for an embedded string. Just change line 840 to:

840 IF INSTR (file\$(f,g),se\$) > 0 THEN 890

Christopher Vann, Yorkshire

## Carbon copy

For the many frustrated DMP2000 users, there's a way to overcome the ribbon problem - use ordinary carbon paper! Place the carbon on the printing paper, making sure there's no crumpling anywhere - to avoid the printer head getting stuck. Use your worn out ribbon, and print! It's a bit troublesome for continuous printing though.

Hj. Khairuddin Ab. Aziz, Malaysia

## Poke a caller

A useful call for your readers:

CALL &BB18 waits for a key to be pressed.

Stephen Mc Cormick, Glasgow

## Green no more

I recently hired a new Finlandia 24 inch TV from Granada. As part of a deal I got a remote control 14 inch portable at no extra cost. My particular model has a silver case and the Granada part number of C14BA2.

The interesting thing is that this set has RGB input capability, via a 7 pin DIN connector on the back of the set. Below is a list of the signals

# PROBLEM ATTIC

Pat McDonald goes on another problem solving escapade. If your CPC's in danger, if you need help, then perhaps you can contact the AA team.

## Future publisher

In the very near future I am hoping to purchase a computer. Could you please give me some help as to the choice of computer best suited to my needs. I wish to publish a small magazine and books while retaining the ability to play games. The Amstrad CPC6128 has been mentioned to me on more than one occasion, but some people say it doesn't have the ROM or RAM to do the job. Could I upgrade it? Also, what does CPM+, GSX and DR Logo mean?

Finally, are there any computer clubs in my area that I could contact for further info and help.

K Wilby, 68 Woodside Crescent, Staincliffe, Batley, W Yorks

*I have taken the liberty of printing your full address, since that way a local computer club (if it exists) might get in touch with you. As for the CPC6128 - we use them to write AA. But you will have to get some extra software for your tasks. Please bear in mind that although there are plenty of word-processor programs to actually type in the words with, if you want to print a magazine you'll need a desk top publishing*

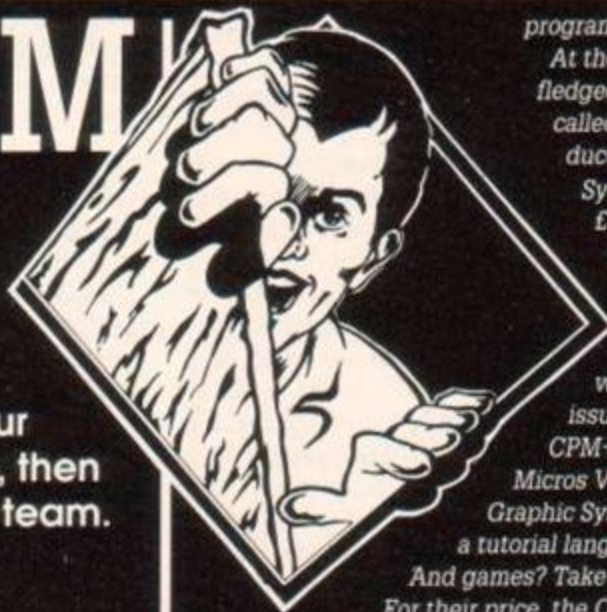

program.

At the moment there is only one fully fledged DTP package for the CPC's. It is called AMX Stop Press, and is produced by Advanced Memory

Systems, ☎ 0925 413501. It costs £49.95, and can produce some

excellent A4 sized results. There are many word-processors available for the CPC's, our most recent recap of them was in the buyers guide in the last issue.

CPM+ means Control Program for Micros Version 3.01 or later. GSX means Graphic System Extensions and DR Logo is a tutorial language - Digital Research Logo.

And games? Take a look at our Action Test pages. For their price, the CPC's can do what you need.

## SmART problem

I typed in the AA29 Type-In called SmART over six evenings, in six parts. Now I've finished I can load them back in one at a time, but I can't load two without losing one of them. Is there any way in which you can save me from the agony of typing it all in again?

Jatinder Daenka, Hayes

*It's easy when you know how. Instead of putting:*

*Simply use merge instead of load*

## Key question

It is a long story, so I will not bother telling it, but I have succeeded in losing the pretty coloured keys from my CPC 464 - that is SHIFT, ENTER, DELETE etc. I have written to Amstrad, who very kindly sent me a leaflet on the PC1640, so I was wondering if you had any sugges-



## Floating point numbers

Anyone who understands machine code will know how to store integer numbers between -32768 and 32767. Here I will explain just how floating points work, ie numbers that are not whole.

The address of a floating point variable can be found by putting an @ symbol in front of the variable name. PRINT @A will print the address where the variable A is stored.

A floating point number takes up 5 bytes, 4 of which are used in the mantissa, leaving one for the exponent. This gives a range of numbers from  $-1.70141 \times 10^{38}$  up to  $1.70141 \times 10^{38}$ . The smallest number which can be stored is  $2.93874 \times 10^{-39}$ .

Byte Number:	0	1	2	3	4
Usage:	MANTISSA				EXPONENT
	Least (significance)				Most

The mantissa uses a signed number format (ie one bit stands for either + or -), and the exponent uses two's complement format.

	MANTISSA (M)				EXPONENT (E)		
Byte:	3...	...	...	0	4		
Bit:	0	1	2...	...	0	1...	6 7
Value:	Sign	$2^{-2}$	$2^{-3}$	$2^{-32}$	$2^0$	$2^1$	$2^6$ $-2^7$

NOTES: If the sign bit is set then the number is negative, otherwise it

is positive. Bit 7 of the exponent is inverted, ie when it isn't set its value is  $-2^7$ , and when it is set its value is 0. The number held can be found by the following equation:

$$\text{Number} = (M \pm 0.5) \times 2^E \quad (\text{With sign dependent on bit 0 of the mantissa.})$$

If all this seems rather complex at first glance then the following program shows you how to decode the number at a particular location.

```
10 INPUT "Address ";addr
20 mantissa=0.5+(PEEK(addr+3) AND 127)*256^-1+(PEEK
(addr+2)*256^-2+PEEK(addr+1)*256^-3+PEEK(addr)*256^-4
30 IF PEEK(addr+3) > 127 then mantissa = -mantissa
40 exponent=(PEEK(addr+4) AND 127)+128*(PEEK(addr+4)<128)
50 number = mantissa * 2^exponent
60 PRINT number
```

After reading this you may be wondering what it can be used for. For a start it allows you to pass the numbers to a machine code routine and decode them, processing them more quickly. You could also decode parts of a Basic program in memory. If you're a student it could give you some insights into the theory of storing numbers on a computer.

M. Buckland, Burgess Hill

Thank you, Mr. Buckland. You have won £20.

and how to wire them to the 6 pin DIN socket of the CPC computers.

The easy part is that the signals from pins 4 and 5 on the CPC go to the DIN plug with no alteration. These are the Sync and Ground signals respectively. (All the pin numbers are marked on the connectors.)

However, pins 1, 2 and 3 had better have a resistor between them and their corresponding pins. A value of about 390 ohms gives a greater

range for contrast and brightness. These pins are used for the Red, Green and Blue signals.

I have had a green screen CPC6128 for over two years, and for the first time I have been able to appreciate the games that make use of the 16 colours that it generates.

Gerard Toon, Cumbria

If I get in contact with Amstrad again, is it likely that they will be able to send me the extra keys - and at what cost! If not, are there any Amstrad dealers/repair specialists who will be able to cater for my problem.

Tristan Mc Donald, 46 Saywell Rd, Luton, Beds

Hmm. I can truthfully say I cannot imagine what Amstrad are playing at. You have two alternatives:

A) Pester Amstrad until they behave in a sensible manner.

B) Consult with Analytical Engineering on 0702 618455. They can supply a new keyboard assembly for £66.44 inclusive. Ouch!

On the other hand, is there anybody out there who will help? Can a loyal AA reader with a broken 464 save him from a mountain of junk mail or an abyss of poverty? Only time will tell - use the above address.

## Trashman

I have recently been writing a program on my CPC6128. When run, the program runs for a time and then returns the error message **Memory Full**. As the program takes up only 7K of memory I presume it is something to do with the amount of variable workspace.

Unfortunately I do not fully understand the memory blocks. I hope you can shed a little more light on the subject and possibly suggest a way round it.

Paul Thewlis, Wakefield

One of the first points I'll make is that the amount of free memory is very much dependent on where the top of memory is, or **HIMEM**. Have you used any **MEMORY** commands? Take a look at last month's First Bytes.

The Amstrad does have a couple of problems when dealing with variables. It tends to forget about redundant variables and lets mountains of garbage build up in memory. To force the CPC to go out and get rid of this rubbish, use the following command:

```
free=FREE("")
```

When you print the value of **free**, this will tell you just how much

space you have left to work in.

Another occasion when the Amstrad can run out of memory is during the **OPENING** and **CLOSEING** of files. The correct way to do this if you have set a rather low memory limit is:

```
OPENOUT "d":MEMORY himem:CLOSEOUT
```

Using this method, and altering the value of **himem** to suit your program, should enable you to load and save files properly.

## Questions and answers

I must congratulate those people who write in with their music programs. I do enjoy them. Will MS-DOS run on the Amstrad CPC464 or 6128? Is there a desk top publishing package that will work with a DMP2160 plus 464 on tape? Can the 40025 chip operate on a ROM board?

I would like a graphics dump program. Any chance of one? What's public domain software? Is the DMP2160 the same as a DMP2000 for the Scanner?

Can I use any of the programs published in your magazine in a program of my own? I noticed your programs have been on Telesoftware recently...

Daniel Williams, Orpington

MS-DOS will not run on the CPC's. There isn't a suitable DTP as far we know. The chip won't work directly in a ROM board, although with a switch and some soldering it should work. (You can't have two ROM zeroes at once.)

We should be printing a graphics dump in next month's AA. Public Domain software is free software - you only have to pay for the cost of copying it, and there is no copyright on it. I assume you mean the Dart Scanner, if so then please tell Dart when you order as a small modification must be made before it will work - they'll do this if they know.

Yes you can use the programs in your own, so long as they are not sold on as your own work.

# Lisp

Pat McDonald gets his tongue twisted

HiSoft, £39.95/£49.95 disk only, all CPC's

HiSoft have a long history of producing CPC software based on upmarket programs. These include the C language and Modula-2. Now they've come up with another - Lisp.

To get into the program you will need to use CPM, either 2.2 or +. This Lisp version is an interpreted one, which means that commands are obeyed as soon as they are typed, just like Basic. Of course, CPM is hardly a fast environment, but the easy availability which this system provides does compensate for a lack of speed.

The Lisp implementation incorporates statements from common Lisp, MacLisp and InterLisp. Six libraries are included on the disk, for these and some other functions:

GOOD NEWS	BAD NEWS
<ul style="list-style-type: none"> <li>Every Lisp feature is there plus some others.</li> <li>Quality documentation.</li> </ul>	<ul style="list-style-type: none"> <li>Interpreted code only at present.</li> </ul>

**INTERLISP.LSP** - contains alternative InterLisp dialect, as well as some other bits and pieces.

**MACLISP.LSP** - as above but with MacLisp names.

**EDIT.LSP** - this provides functions to take statements out of a program written under the interpreter, and transfer it to the 6128 editor.

**TRACE.LSP** - gives trace facilities for debugging new programs.

**STRING.LSP** - contains some string handling functions which use standard Lisp protocol and identifiers.

**MATH.LSP** - some mathematical functions.

The graphics and joystick port of the CPC are supported within Lisp. Also it is possible to incorporate machine code routines and call

them within the language, for some extra byte-crunching power.

For long programs you get a free text editor to handle program writing. This shares some key combinations with WordStar, and is powerful enough to warrant its inclusion. You can of course use a true word-processor if you prefer.

The manual and documentation of the program are of an amazing standard for such a meaty subject. Admittedly there is no full Lisp tutorial but the background information is all there in its proper place. It even recommends a book if you don't already understand the language structure - for an extra £10 this is included.

It will be interesting to see just how popular HiSoft Lisp becomes. For myself, I wish it every success, although a compiler program to produce stand alone code would be the icing on the cake.



## Historical Lisp

Lisp was developed in the 1960's for LIST Processing. It's speciality is going through long lists of words or numbers, adding, slicing and analysing them.

The purposes for which Lisp was and is used are artificial intelligence, expert systems and analysis. Being able to process words rather than numbers is a very powerful feature, and Lisp has gained many adherents. HiSoft Lisp really does shine out for the student and the dilettante. Any chance of a compiler, HiSoft?

# Rodos Extra

Romantic's latest hits the streets. Pat McDonald checks it out.

Romantic Robot, £9.95 disk & Rodos only

Rodos, the ROM based alternative disk operating system from Romantic Robot, received a favourable review in AA25. Richard Monteiro enthused over it, but bemoaned the poor manual and lack of explanation. Here's the answer: Rodos extra!

Rodos Extra is supplied on a disk, with no documentation or manual in sight. Hmm. There's a file on it called DISC so surely if I run it... it tries to re-format the disk. Romantic have assured us that this won't happen on production versions. Personally I think that this due to the rather strange mixture of ROMs on my 6128.

The menu presents you with several options. There are a couple of utilities, one being a rather slow disk editor, another a PC/MS-DOS disk reader. There are also some for copying to and from Rodos format disks, creating a disk format of maximum capacity. What they are is in this case not as important as why they're included.

All the programs are written in Basic and use the extensions for Rodos. The whole idea behind them is that the user makes a study of

GOOD NEWS	BAD NEWS
<ul style="list-style-type: none"> <li>In depth information for Rodos users.</li> <li>Some utilities too.</li> <li>Not too expensive...</li> </ul>	<ul style="list-style-type: none"> <li>But it could have been included the first time around.</li> </ul>

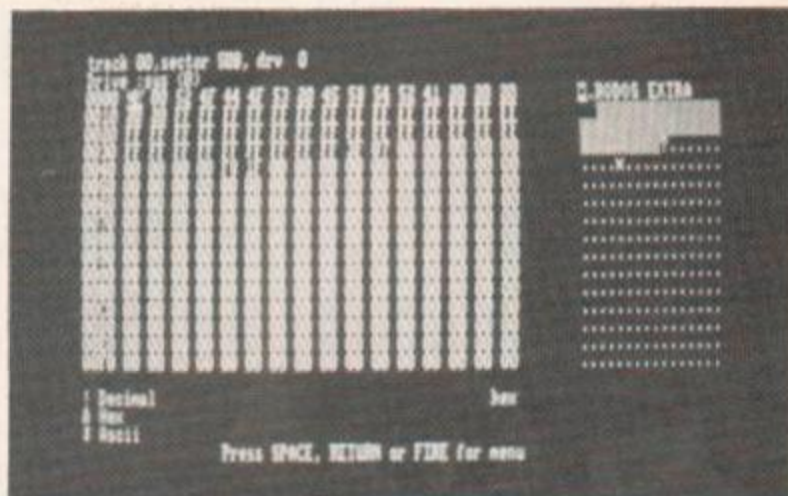

● The disk editor in action.

them in order to discover some of the points not covered in the Rodos manual. Getting into them is pretty easy and they are quite well written. It's a better way to educate than having a huge manual to wade through.

Also on the disk are a huge number of help files in order to ground the naive user in Rodos. There really is lots of stuff here to read about and digest. For the new user it can be a bit daunting, but after having read through it I feel a lot happier with Rodos.

Included as a Basic program is a circuit diagram. If you build this then you can connect multiple extra external disk drives to your machine. Of course, you will need a software patch as well...

All things considered I'm very impressed with Rodos Extra. It does seem a worthwhile extra for those who already have Rodos, and although the quality of the programs themselves isn't of the highest the documentation makes up for it.

**FOOTBALL & CRICKET**

QUALITY STRATEGY GAMES from E &amp; J SOFTWARE (Established 1984)

**EUROPEAN CHAMPIONS** ★ NEW ★ - THE INTERNATIONAL CHALLENGE OF THE EUROPEAN NATIONS CUP - Genuine Nations Cup Format with full Random Draw of 32 Seeded Teams - Fixture List, Results and League Tables of ALL 8 Groups - Discipline & Medical Reports - Squad of 22 Players plus Other Players available - 17 Month Itinerary of Qualifying Group (Arrange Friendlies) and Finals - Plus many more Superb Features and Options. EUROPEAN CHAMPIONS includes E & J's **MATCH PLAY SYSTEM** an imaginative and exciting new style of match presentation which captures the ACTION, DRAMA & TENSION of International Football.

**WORLD CHAMPIONS** - A COMPLETE WORLD CUP SIMULATION - Select Friendlies - 25 Players - Qualifying Group - 2 In-Match Subs - Discipline Table - Select Tour Opponents - Extra Time - Final Rounds - Players Gain Experience - 7 Skill Levels - TEXT MATCH SIMULATION including: Bookings, Goal Times, Named & Recorded Goal Scorers, Injury Time, Corners, Free Kicks, Match Clock, Penalties - PLUS many more Features.

**PREMIER II** - CAN YOU HANDLE ALL OF THIS? - Play all Teams Home & Away - Unique Transfer Market - Team & Substitute Selection - Named & Recorded Goal Scorers - Injuries - Transfer Demands - Continuing Seasons - Squad Listing ALL Teams Financial Problems - 7 Skill Levels - Offers to Manage other Teams - Sackings - Managers's Salary - Save Game - Team Styles - Bank Loans - AND many more Features.

**EUROPEAN II** - THE MOST COMPLETE SIMULATION OF EUROPEAN CLUB FOOTBALL YOU CAN BUY - Home & Away legs - Full Penalty Shoot-Out (with SUDDEN DEATH) - 2 In-Match Subs - Away Goals count Double (if Drawn) - Full Team & Sub Selection - Extra Time - 7 Skill Levels - Enter your own PREMIER II Winning Team - TEXT MATCH SIMULATION plus Sending Off and Disallowed Goals - Results Table - PLUS MUCH MORE!

**CRICKET MASTER** - A SUPERB SIMULATION OF ONE DAY INTERNATIONAL/COUNTY CRICKET - Weather, Wicket & Outfield Conditions - Batting & Bowling Tactics - Team Selection - Fast, Medium & Spin Bowlers - 4 Types of Batsmen - Select Field Layout - 3 Skill Levels - Wides - Byes - No Ball - Run Out - Misfield - Dropped Catches - Scoreboard - Batting & Bowling Analysis - Run Rate - Single Option - 3 Game Speeds - STAR FEATURE a complete MATCH OVERVIEW showing Ball by Ball Action and Commentary and MUCH MORE!

**TEST MASTER** ★ NEW ★ A COMPREHENSIVE SIMULATION OF A 5 DAY TEST MATCH - Includes most of the Features of CRICKET MASTER and MATCH OVERVIEW plus Declarations - Nightwatchmen - Light Meter - Rain Stops Play - Varying Number of Overs per Day - Follow On - Save Game - New Ball - Bad Light Interruptions - TEST MASTER is a True representation of a Complete Test Match and offers the ULTIMATE CHALLENGE to All Cricket Enthusiasts.

CRICKET MASTER &amp; TEST MASTER prices include a FREE pad of SCORESHEETS

Software availability	Spectrum Any 48/128K		Commodore 64/128K		Amstrad CPC	
	Tape	Disc + 3	Tape	5 1/4" Disc	Tape	3" Disc
EUROPEAN CHAMPIONS	£7.95	£11.95	n/a	n/a	n/a	n/a
WORLD CHAMPIONS	£6.95	£10.95	£7.95	£10.45	£7.95	£11.95
PREMIER II	£6.95	£10.95	£7.95	£10.45	£7.95	£11.95
EUROPEAN II	£6.95	£10.95	£7.95	£10.45	£7.85	£11.95
CRICKET MASTER	£7.95	£11.95	n/a	n/a	£8.95	£12.95
TEST MASTER	£8.95	£12.95	n/a	n/a	n/a	n/a

FANTASTIC VALUE: Special Discount of £2.00 for every EXTRA game purchased (e.g. buy 2 Games deduct £2.00 from TOTAL - buy 3 Games deduct £4.00 from TOTAL - 4 Games £6.00 etc).

ALL GAMES are available by MAIL ORDER for IMMEDIATE despatch by 1st class post and include Full Instructions. (OUTSIDE UK please add £1.00 for postage and send payment in Pounds Sterling only).

PLEASE STATE WHICH MACHINE AND TAPE OR DISC. Cheques or Postal Orders payable to E & J Software.

Send to: E & J SOFTWARE, Room A1, 37 Westmoor Road, ENFIELD, Middlesex EN3 7LE.

**REAL SPEECH FOR YOUR 6128**

\*MUCH MORE REALISTIC THAN SPEECH SYNTHESIZERS.

\*NO MESSY PHONE PROGRAMMING, JUST USE BUILT-IN MICROPHONE.

\*32K ON-BOARD BATTERY BACK-UP CMOS RAM, STORES 16s SPEECH.

\*EXPANDABLE TO 128K (1mb on board), OVER 1 mb/side ON 3" disc.

\*DOUBLES AS RAM DISC, MUCH SAFER THAN CONVENTIONAL MODELS.

\*SOUND EFFECTS - MESSAGES - EDUCATIONAL - MEDICAL - ETC..

\*PLUGS INTO BUS OF 6128 (MODELS WITH CARD-EDGE CONNECTOR).

\*INTRODUCTORY UK PRICE: FF 845.00 OR £ 79 (ex VAT, Inc P&amp;P).

## ORDER FORM

POST TO: E.N.M., 7 rue MELINGUE, 75019 PARIS - FRANCE

PLEASE SEND ME... DIGITAL SPEECH INTERFACE(S), 32K VERSION.

I ENCLOSE...

(EUROCHEQUE, BANK DRAFT OR INTERNATIONAL MONEY ORDER.)

PLEASE SEND PRICING INFORMATION ON 64K/96K/128K VERSIONS.

NAME.....

ADDRESS.....

**SIREN SOFTWARE****DISCOLOGY**

This program really is the ultimate in disc utilities.

Just look at these features:-

- Disc copier will backup 99.9% of all Amstrad discs
- Copy multiple files in one go
- Will also transfer files from tape to disc and disc to tape
- Will work with 1 disc drive but if 2 are available, it makes use of both.
- Uses full 128K on a 6128 or 64K on a 464/664. Utilises any memory expansion.
- Edit any sector regardless of format.
- Display sectors in Z80 disassembly, Hex, Ascii, Binary, Octal, Decimal and even as a basi listing!
- Search disc/file for a given string, Dump screen onto a printer.
- Built in calculator for Hex to decimal conversions etc
- Full graphically displayed explorer
- Exceptionally easy to use. Uses pull down windows and menu etc
- Many other unique features.

Available now on disc at **£14.99 CPC 464/664/6128**Masterdisc/Oddjob owners, we will put Discology on the B side of your disc for only **£9.99****DISCOVERY PLUS**

★★★ NEW ★★★ DISCOVERY PLUS ★★★ NEW ★★★ UPDATE

The best selling tape to disc transfer program for the AMSTRAD has now been upgraded to transfer many more programs with a lot less hassle.

- ★ Will transfer programs from all the top software houses. (Ocean, US Gold etc)
- ★ All transferred programs "stand alone" with this new version
- ★ Very easy to use, ideal for the novice user.
- ★ Transfers the majority of Amstrad software from tape to disc. Will cope with normal loaders, headerless loaders, Speedlock and flashloading programs.
- ★ Compatible with the 464/664/6128. Makes use of extra 64k on a 6128.

**DISCOVERY PLUS**  
available now on disc only **£14.99**Existing owners can upgrade to the new version for only **£8.99.**  
(No need to return original disc.)

**SIREN SOFTWARE TEL 061 228 1831**  
**2-4 OXFORD ROAD, MANCHESTER M1 5QA**



# DISCOUNT SOFTWARE

from M.J.C. SUPPLIES

## DISC GAMES

ATF	11.95
Battlefield Germany	13.95
Blood Bros	11.95
Brian Clough Football	14.95
Bubble Bobble	11.95
Buggy Boy	11.95
California Games	11.95
Captain Blood	11.95
Champions	14.95
Colossus 4 Chess	11.95
Combat School	11.95
Conflicts	14.95
Dark Scale	11.95
Driller	14.95
Druid II	11.95
Elite	10.95
Flying Shark	11.95
Gauntlet II	11.95
Gryzor	11.95
Hewson Smash Hits	11.95
Impact	11.95
Karnov	11.95
Konami Arcade Collect	14.95
Lucas Film Collection	11.95
Magnificent Seven	14.95
Master Of Universe	11.95
Nebulus	11.95
Out Run	11.95
Pirates	14.95
Platoon	11.95
Predator	11.95
Prohibition	11.95
Renegade	11.95
Revenge Of Doh	11.95
Road Runner	11.95
Scrabble Deluxe	12.95
Starglider	16.95
Star Wars	11.95
Sorcerer Lord	13.95
Super Hand-On	13.95
Tetris	11.95
The Pawn 6128	16.95
ThunderCats	11.95
Trantor	11.95
Trivial Pursuits	16.95
Wonderboy	11.95
World Class Leader	11.95
Yes Prime Minister	16.95

## 6128 - INFOCOM GAMES

Hollywood Hi Jinks	19.95
Leather Goddess	19.95
Lurking Horror	19.95

## EDUCATION

Animal Veg. Mineral	11.95
Answerback JNR Quiz	11.95
Factfile Arithmetic	7.95
Factfile Spelling	7.95
Factfile Sports	7.95
Fun School 2-5 years	7.95
Fun School 5-8 years	7.95
Fun School 8-12	7.95
World Wise	11.95

## DISC SERIOUS

Qualitas Plus	12.95
Rodos Extra disc	8.95
Spanish Tutor	16.95
French Mistress	16.95
German Master	16.95
Italian Tutor	16.95
Maxam ass/diss	21.95
Protext	21.95
Prospell	20.95
Promerge	20.95
Protext (CPM version)	49.95
Plan-it	15.95
Tasword 6128	19.50
Taspell	12.95
Tasprint	10.95
Tascopy	10.95
Tasdiary	10.95
Tassign 6128	23.95
Matrix Spreadsheet	29.95
Mastercalc 128	28.95
Masterfile	32.95
Mini Office II	15.95
Advanced Music System	25.95
Advanced Art Studio	19.95
Armor Filer	21.95
Armor Office Suite	29.95

## CPM BASED

Supercalc 2	41.95
Dr Graph	39.95
Dr Draw	39.95
Dr CBasic	35.95
Dr Pascal MT+	35.95
Armor C Compiler	39.95
Maxam II	39.95
Nevada Fortran	35.95
Nevada Cobal	39.95
Hisoft Lisp	39.95
Hisoft Devpac 80	39.95
Hisoft Pascal 80	39.95
Hisoft C Compiler	39.95
Hisoft Fourth	18.95
Iankey 2 Finger Typing	21.95
Iankey Crash Course	21.95

## CASSETTE BASED

Maxam 464	16.95
Protext 464	16.95
Tasword 464	15.95
Tascopy 464	8.50
Tasprint 464	8.50
German Master 464	14.95
French Mistress 464	14.95
Answerback JNR Quiz	8.95
Factfile Arithmetic	4.50

## ACCESSORIES

Multiface II (Rom)	41.95
Printer Lead 1M	8.95
Printer Lead 1.5M	9.95
Printer Lead 2.0M	10.95
RS232 Leads (various)	11.95
DMP 8K Buffer Kit	9.95
Mono Screen filter	12.95
Colour Screen Filter	14.95
Comp Pro 5000 joystick	13.95
Quickshot Turbo Joystick	12.95
Cruiser Joystick	9.95
6128 Light Pen	26.95
464 Monitor Ext Leads	6.95
6128 Mono Ext Leads	7.95
Single CF2 Disc	2.95
1000 Fanfold Labels	5.95
Spike Protector Plug	11.95
Second Drive Lead	7.95
DKT 64K Memory Exp	39.95
AMS 20L Disc Box	11.95
AMX Mouse + Art	85.95
AMX Mouse + Stop Press	75.95
464 Dust Cover (Mono/Col)	7.95
6128 Dust cover	7.95

## BOOKS/MANUALS

Intro to CPM+	7.95
Adv Amstrad Graphics	7.95
Mastering Machine Code	8.95
DDI Firmware Spec	9.50
The Amstrad CPM+ Book	12.95
128 Firmware Spec (968)	17.95
Programming the Z80	19.95

## SPECIALS

DMP 2000 Ribbons	x 1	3.95
	x 2	7.00
	x 5	16.00
Genuine Amsoft CF2 Disc		
	x 5	12.00
	x 10	22.95
	x 20	42.95

## ROM BASED

Maxam	32.95
Protext	32.95
BCPL	32.95
Utopia	24.95
Prospell	29.95
Promerge+	29.95
Rodos	38.95
Cage Rom (State which I/Face)	31.95
Rombo Rom Board	33.95
Rombo (with any Rom)	29.95

## M.J.C Packages

Qualitas Plus  
KDS 8 Bit Port  
Display Font Pack  
R.R.P £44.45  
Package Price £34.95

Protext Rom  
Utopia Utilities Rom  
KDS Rom Board  
R.R.P £99.80  
Package Price £75.95

## NEW PRODUCTS

KDS 8 BIT PRINTER PORT  
gives your printer more flexibility  
ideal for use with QUALITAS.  
MJC Price: £18.95

KDS ROM BOARD (holds 6 ROMS)  
MJC Price: 25.95

KDS RS232 INTERFACE: including  
Comms software built in on Rom  
MJC Price: £45.95

KDS 5.25" DISC DRIVE: For use as a  
second drive, complete with software  
& lead. Plug in and go  
MJC Price: £139.95

## CORNIX SIMPLE ACCOUNTS

Ideal for the small trader, easy to use  
features sales, purchase and debt  
analysis and also gives you figures  
for the VAT return  
MJC Price: £34.95

## HARDWARE

FD1 DISC DRIVE (lead extra)  
DD1 DISC DRIVE

AMSTRAD RS232 INTERF  
including Commstar software  
MJC Price: £55.95

AMSTRAD V21/23 MODEM (ie  
MJC Price: £95.95

LINNET MODEM V21/23: Fe  
autodial and autoanswer, 3 hell  
and 32 number store  
MJC Price £144.95

DMP 2160 PRINTER New 16  
MJC Price: £159.95

LQ3500 PRINTER: 24 pin hel  
160 CPS and very good N  
MJC Price: £299.95

ALL ABOVE PRICES INCLUDE VAT, POSTAGE & PACKING IN THE U.K

THE ABOVE SOFTWARE IS ONLY FOR THE AMSTRAD CPC RANGE  
PCW AND PC OWNERS PLEASE WRITE FOR DISCOUNT PRICES

Overseas Orders Welcome - Please write for details

WE ARE NOW IN OUR FOURTH YEAR OF SPECIALISING IN AMSTRAD MAIL ORDER, OUR POLICY IS TO PROVIDE  
THE WIDEST RANGE AT DISCOUNT PRICES WITH A FAST TURN AROUND TIME - TRY OUR SERVICES WITH  
CONFIDENCE

NOW IN NEW PREMISES - CALLERS WELCOME!

PLEASE SEND CHEQUES/POs TO:

# M.J.C SUPPLIES, (AA)

40a Queen Street, Hitchin, Herts. SG4 9TS.

Tel: (0462) 32897/420847 for enquiries/Credit Card orders

VISA



# ACTION TEST

There's a unique first this month because the sequel to a Mastergame has itself become the Mastergame. The game that has achieved this double is Dark Side, follow up to Driller.

Captain Blood is the latest graphical masterpiece from France, while the addiction level is kept high by another breakout clone - Impact. Not forgetting Eddie the Eagle's own skiing game!

<b>Mastergame</b>	Ey45	
<b>Page</b>	GeeBee Air Rally	43
Darkside38	Karnov	44
<b>Raves</b>	Lazertag	44
Captain Blood40	Metal Army	53
Impact	On Cue	53
<b>Games Reviewed</b>	Race Against Time	45
Blood Brothers43	Soccer 6128	46
Eddie Edward	Streetfighter	46

## EDDIE EDWARDS' SUPER SKI

Loricels, £9.99 cass, £14.99 disk, joystick or keys

Britain's Olympic failure, Eddie Edwards, has lent his name to a skiing game from France. Will you do as well as Eddie in the four events that you get, or will you manage come somewhere other than last?

On the screen you get a rear view of the skier with the snowy landscape in the distance. To the right is an indicator to remind you of which event and which player's turn it is. At the bottom of the screen is a digital display of time elapsed since the event began and the number of gates that you missed, if appropriate.

### SECOND OPINION

*The game is certainly a lot better than Eddie is at ski-jumping - but that's hardly a demanding task. The events are proficiently put together and convey an excellent impression of speed. What they lack is variety. The three races are very similar in nature and it's simply a matter of perfecting your style and learning the various runs. Why don't your glasses steam up so that you can't see where you're going?*

BW

### GREEN SCREEN VIEW

*No problems in green.*

There are four events in all: the slalom, downhill, jump and giant slalom. Before play begins you get the choice of training or

competition play. Training is a single player game where the same event is practised to perfect your technique until you quit back to the menu. Competition is for up to six players, you compete against each other and must go through all four events. You have two attempts at each event and the scores are added together.

The ski jump is probably the easiest of the events to do, it's simply a matter of going down the ramp and flying through the air. While in the air you can lie really flat to get that extra bit of distance, but if you land that way you'll end up with a mouthful of snow. In the downhill you have a course clearly marked and you have to get to the end of it in the shortest possible time. Gates appear occasionally and failure to go through them adds to the penalties.



● Weaving between gates on the slalom

Both of the slalom events have many more gates than the downhill and if you don't pass through them the number of penalty points goes up. Points are awarded at the end of each course according to how fast you completed it and points are subtracted for penalties. Your first few races will end with a score of zero in all probability, until you know the course. The two slaloms and the downhill each have three different pistes to race down. Of the four events the ski jump is the one you'll tire of first because there's only so far that you can jump.

During the championship the scores for every player are displayed at the end of each round of the contest. After all events have been played the winner is declared. Then it's just a matter of beating high scores.

Sound is virtually non-existent, you go whoosh down the slope and that's it. The graphics on the other hand are very fast and colourful. To get everything fast the movement of the background is jerky, but you won't really notice it because just trying to stay between the flags is tricky enough.

It's fun to play to begin with, but in the long term there's not really that much to do. You can beat your high scores and set faster times, but there's nothing else to it. The multiple player option will add a little to the competitive spirit, but not that much. GBH

### FIRST DAY TARGET SCORE

Get a non-zero score on one of the races or 57M on the ski jump.

### The Verdict

**GRAPHICS** ..... 83%

- Very fast moving graphics
- Detailed and colourful backgrounds

**SONICS** ..... 13%

- Whoosh.

**GRAB FACTOR** ..... 82%

- The potential for up to six players adds to the interest.
- Unless you're a sports game fan you may not find it exciting.

**STAYING POWER** ..... 67%

- Four different events and different pistes to race down.
- After a few games you'll find little to keep you occupied.

**AA RATING** ..... 76%

- Great graphics and fast moving action...
- but not really enough game in there.

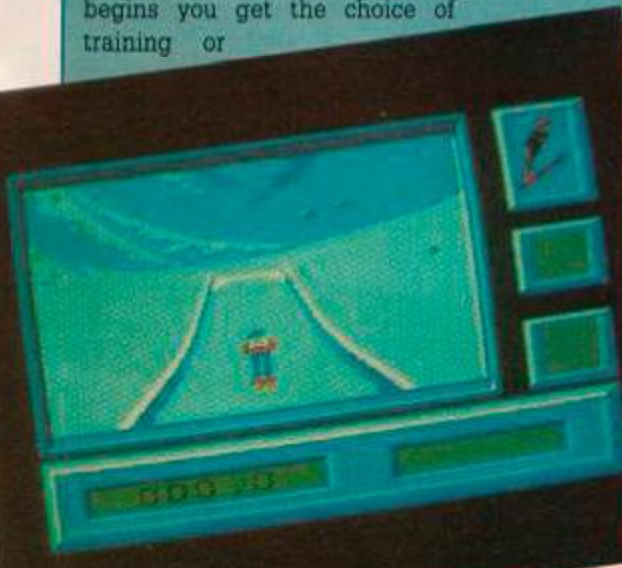

● Flying through the air

# DARK SIDE

Incentive, £9.95 cass, £14.95 disk, joystick or keys

The eagerly awaited follow up to the Christmas *Mastergame*, *Driller*, has arrived. The setting this time is the other moon of Evath, Tricuspid, 200 years after the events of *Driller*. The Ketars have been planning their revenge for a long time and now they are ready. They have built a huge weapon called

work of energy collection devices (ECD's). The only way to stop the weapon from firing is to disable all of the ECD's. Time is passing and soon your homeworld will be no more, unless you complete the mission hastily.

You arrive on Tricuspid armed

they can be disabled at any time, but others have many wires trailing and they are the tricky ones. An ECD is disabled when the top is shot, but if the ECD is connected to two or more other ECD's then it will regenerate. Because of the regeneration you have to plan very carefully and so strategy comes into play. You then have to follow the cables until you find an ECD that's only connected to another single ECD. In the first few games you'll run out of time rapidly, but after that you'll be able to disable a large chunk of the network in a matter of minutes.

Tricuspid is not left unguarded though, there are killer satellites orbiting the moon, Plexor tanks wait in some sectors and there are sensors that throw you into prison if they detect

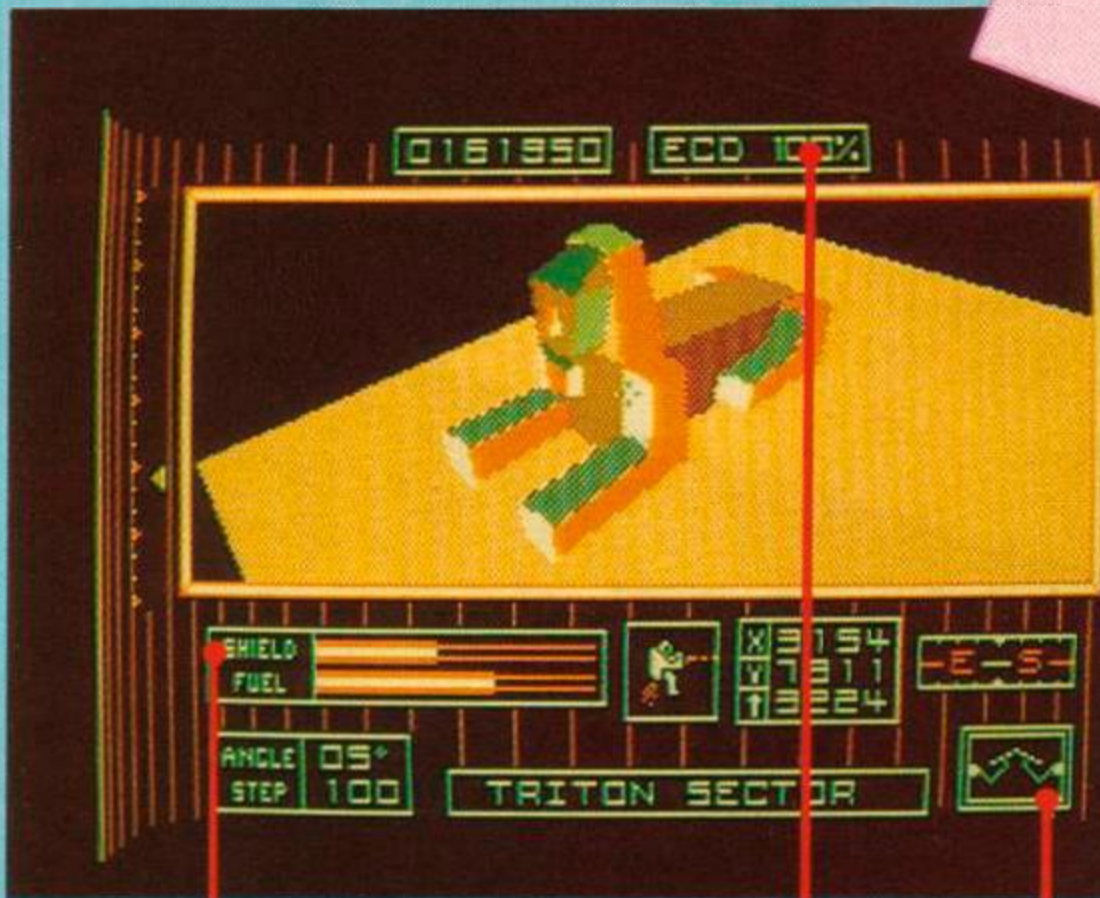

The status of the ECD network alters the rate of powering up the Zephyr One

If you run out of shields you'll die

This little box indicates which mode you're in, attack or movement

Zephyr One, on the dark side of the moon. As soon as the weapon is fully charged it will fire and Evath will end its' days as a meteorite shower.

A lot of power is required to destroy a planet and this is obtained through a vast net-

### SECOND OPINION

*Congratulations to Incentive on producing another superb game. It uses many of the ideas first spotted in Driller, but introduces whole new elements of arcade gameplay to complement the puzzling. I didn't like the graphics as much - they're a little more sombre - but the gameplay is magnificently addictive and full of surprises. A must for any game-player.*

BW

### GREEN SCREEN VIEW

*You'll have no problems playing it in green.*

with a laser and wearing a shielded spacesuit and a jetpack. The jetpack has a limited fuel supply, so care has to be taken when using it. The shields will only take so many hits before you die. The screen represents the view from your space suit helmet and is split into two areas. The main area gives you a view of Tricuspid through the helmet and around it are various pieces of information. Your position, compass bearing and altitude are given, along with fuel and shield status.

Shields and fuel can be regenerated by finding power sockets and fuel rods respectively and walking into them. At the right of the screen is a binary counter that gradually creeps upward, Zephyr One fires when it reaches the top.

Initially the time shoots up very quickly and the ECD network is at 100%. Every time you disable an ECD the networks power decreases by 4% and so does the rate of charging. All of the ECD's are connected to the Zephyr One by long cables running from their bases. Some have a single cable and

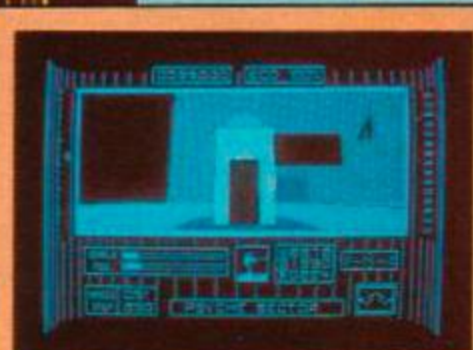

The telepod capsule will take you around the planet



Aerial view of Tricuspid courtesy of your jetpack



Plexors guard some of the sectors

# MASTER GAME

## The Verdict

### GRAPHICS ..... 89%

- Excellent perspective on the landscape.
- Detailed and colourful objects.

### SONICS ..... 38%

- Simple effects, but the jetpack sound is particular good.

### GRAB FACTOR ..... 93%

- The panic element adds greatly to the gameplay.
- The first 50% of the game is quite easy to solve and it soon has you hooked.

### STAYING POWER ..... 92%

- Completing the rest however is much more demanding.
- Plenty of intriguing puzzles to solve.

### AA RATING ..... 92%

- *Driller* was good, but *Dark Side* is even better because of the more logical problems and tighter time limit.
- We haven't rated it as highly because this time round it's not as original.

you. Getting out of prison is a puzzle in itself and I'm not going to tell you how to do it, you'll solve it - eventually. Outside the prison cell you'll find a network of tunnels that you can use to move around the moon as an alternative to surface travel. When you want to return to the surface then you just find a trapdoor in the roof and jet out through it.

Another way of travelling around the moon quickly is through the powerporters, which are large slab like objects that teleport you around. The telepod does a similar thing but it has been disabled by removing the four telepod crystals that power it. Before you can use it you'll have to replace the crystals in their sockets. If you manage to disable all of the ECD's then the Zephyr One will go boom and if you don't, then you better start looking for a new planet to live on. Either way you'll get to see a graphical representation of the destruction.

The graphics are just as good as those in *Driller* and they are slightly faster. Sound is also slightly improved, but it's still not particularly spectacular. The playing area is a little larger than that in *Driller* due to the extensive underground network. Control is very similar too, the only change being that instead of placing drilling rigs on the moon you can switch on your jetpack.

*Driller* was an excellent game but it lacked one thing, panic. The pace of *Dark Side* is set much higher and as you watch that timer creeping ever upward you'll begin to get more and more nervous. Completing the task is not going to be an easy one, it will probably take even longer to complete than

its predecessor. If you were put off *Driller* by the price, then you've got no excuse this time because it's dropped to that of most other games. If you enjoyed *Driller* then you'll

find plenty to keep you occupied in this.  
GBH

### FIRST DAY TARGET SCORE

Disable 50% of the ECD network.

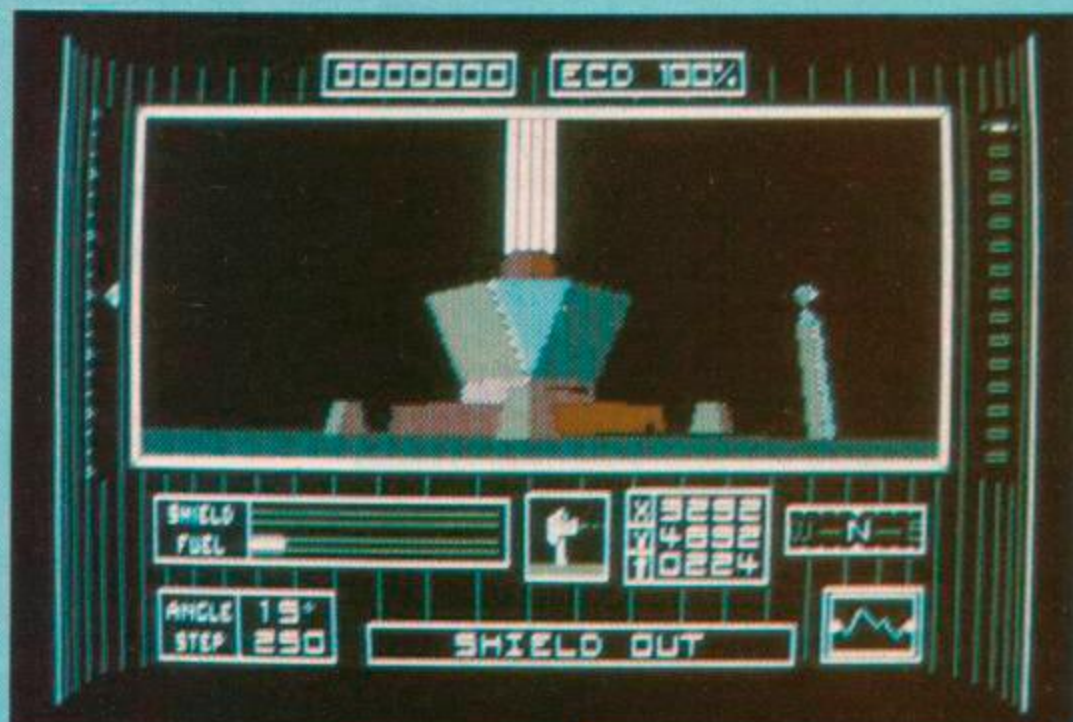

● If you fail in your mission then Evath gets zapped

Your score appears here

The binary counter ticks away the time to firing

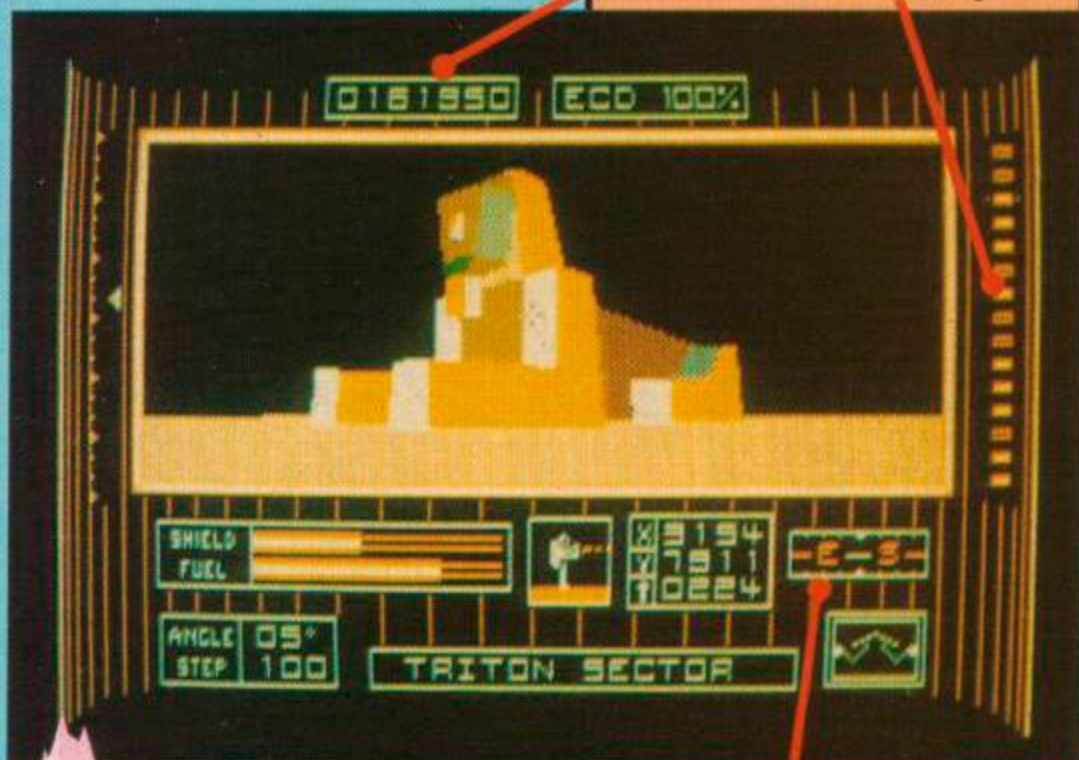

You have a magnetic compass to give your bearings



## CAPTAIN BLOOD

Infogrames/Ere, £9.95 cass, £14.95 disk, joystick or keys

Travelling through hyperspace can be a hazardous business, especially if you have to enter it hastily and without preparation. Captain Blood will definitely agree here because he had a simple choice – die at the hands of hordes of hostile aliens or get out of there fast. He chose the latter and because of a malfunction in his spaceship, Blood was not

the only one to re-enter normal space at the end of the journey, thirty clones appeared throughout the galaxy.

In the next 800 years Blood travelled around the galaxy finding his clones and eliminating them, after all one Blood is enough for anyone. Now there are only five left to find, but things have not been too good for Blood either. The cloning process had deprived him of large portion of his vital fluids. For each of the clones that he'd found some of his vital fluids had been replaced to let him keep on living. Time was running out though, he couldn't survive for much longer with a single clone left in existent.

There are four main screens that can be accessed during the game: a view of the planet that you are currently in orbit around, a view through the eyes of the oorxx (a baby spaceship-type being), a map of the galaxy and the alien communication screen. The planetary view screen just lets you watch it spin on its

axis, but it's also used in the destruction sequence.

The galaxy map has an overhead view of the galaxy and you select your destination by letting your finger do the walking.

The oorxx is used to either destroy, photograph or land on the planet – it all depends which variety you launch from your ship. Your first choice will probably be a landing because you need information. There are lots of planets out there and you don't have time to destroy every one of them. Your oorxx is launched and you then have to guide it to an alien. For some strange reason all of the aliens in the galaxy live at the end of canyons and so you have to pilot the oorxx towards them. Some planets are defended and so you have to fly at low altitude to avoid the missiles. When you reach an alien the view will switch to the communication screen.

The alien will then start to speak to you and the universal communicator will be needed to translate what has been said. To find out what the symbols mean you just have to move Blood's finger over the symbols. When the alien has run out of things to say you can speak back to it using the same symbols. There are many different aliens and they each have their own personalities. It is possible to



● Speaking with aliens is an integral part of the game



## IMPACT

Audiogenic, £9.95 cass, £14.95 disk, joystick or keys

If you count all of the breakout clones that have come out in the past year then you'll be approaching double figures. The best of them up to now has been *Arkanoid* and its sequel *Arkanoid II*. Can Audiogenic take the title from Imagine?

There are no prizes for guessing that on the screen you get a row of bricks at the top and a bat at the bottom. To the right of the screen is a panel that shows the level, number of lives, score and a set of nine icons. You'll find plenty of levels to keep you occupied with this one, there are 80 in all and you also get a screen designer with the game to give you another ten levels of your own creation. You begin play with five lives, bonus ones being awarded every 50,000 points.

The icons are what make the difference in this game, because rather than having random capsules falling from the blocks when they're destroyed, like in *Arkanoid II*, you get staples. They're special staples though because when you collect them the icon pointer moves along a place. Icons are activat-

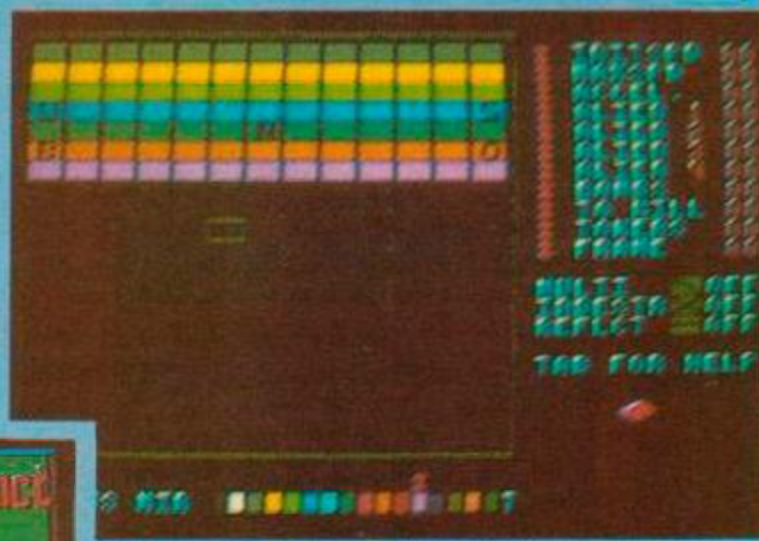

● The screen designer with a partially completed screen

ed by pressing a key, the pointer is then reset to the start. The nine icons are: slow, magnet, divide, wide bat, torch, laser, smart bomb, missile and forcefield.

There are several different sorts of block in the game: indestructibles, reflective, invisible, bonus, multiple hit and normal blocks. The reflective blocks are dangerous because they bounce laser bolts back and reflected bolts destroy the bat. Invisible blocks can be seen when they're hit by the ball and also when the torch is active. The bonus blocks each have a letter in them, if you spell out the word "bonus" in the correct order then you receive an extra life.

Another thing makes this different is that the 80 levels are split into groups of ten. Once you've complet-





## The Verdict

## GRAPHICS ..... 91%

- Excellent graphics throughout.
- The planet explosion is tremendous.

## SONICS ..... 43%

- Great title tune.
- The in-game effects are not so good.

## GRAB FACTOR ..... 87%

- Using alien communication is original and intriguing.
- Initial confusion may put you off playing, you'll need perseverance.

## STAYING POWER ..... 78%

- It's a long term task to fly around the universe clone bashing.
- Somehow I doubt that you'll play it again once you've done it though.

## AA RATING ..... 81%

- Infogrames seem to have got their act together again, perhaps their next game will be even better.

teleport the aliens onto your ship, but only if they're willing. The aliens may give you infor-

mation only after you've done something for them, like destroyed another planet or taken them somewhere. Information is in the form of the coordinates of a planet.

Travel from planet to planet is via hyperspace and upon arrival you again get a view of the new planet. The procedure is repeated until all of your clones are destroyed or you degenerate and die. The destruction sequence is activated when you send an explosive oorxx onto the planet. It speeds up it's rotation and then explodes dramatically.

## SECOND OPINION

*It's certainly a very impressive collection of graphic sequences to delight the eye. The gameplay is slightly more difficult to cope with. The flying sequence is the only arcade action, most of the game consisting of learning the art of alien conversation. You may find it becomes stale after a while, but it's a very novel game structure which will intrigue and delight many.*

BW

## GREEN SCREEN VIEW

*It loses a lot of the graphical appeal in green, but there are no problems playing the game.*

Sound in the game is limited to only the occasional spot effect, but there is a futuristic piece of music played on the title screen. Graphics are the strongest point though, the galactic map is excellent and the other screens that crop up are of a similarly high standard. Each of the aliens is well animated too.

Initially you may be confused when playing this because you won't know what to say to the aliens and as a result you'll come to a dead end. After a few games though things will begin to slot into place. Conversing with aliens is fun, but there are not that many possibilities in what you can say. It all boils down to zooming around the universe trying to find your clones and then blasting them into lots of little pieces. It's a vast improvement on recent Infogrames products, but still lacks a little something in the gameplay.

GBH

## FIRST DAY TARGET SCORE

Destroy one of your clones.



ed every tenth level you're given a password that allows you to begin a game from a more advanced point. It makes it a little easier to complete, but at least you don't have the frustration of reaching the level you're stuck on and losing all your lives so quickly. The screen designer is a nice touch too, because it means that you can design the last ten levels and when you solve them you can redesign them all over again.

The animation of the ball and staples is a bit dodgy, they flicker a little, but the blocks and bat are fine.

## SECOND OPINION

*OK so it's just another Breakout clone, but it is the best. Simple arcade action like this will always have great appeal and personally I would still play the original if I could lay my hands on a machine. The most impressive thing about this variant is the number of screens and the fact that you can design your own. Mix that in with fast, exciting action and you've got a very addictive game.*

BW

## GREEN SCREEN VIEW

*Some blocks, especially the dark blue, are almost invisible.*



Sound is what you'd expect for a breakout game, it consists of bouncing balls and the occasional other effect crops up.

One thing that this has over *Arkanoid II* is that the ball didn't get trapped in an endless loop at any time. There's also the screen designer which is a plus and there are loads of screens to complete. If you want a breakout variant then this is currently the best.

## The Verdict

## GRAPHICS ..... 65%

- Bright and colourful blocks.
- Poorly animated ball and staples.

## SONICS ..... 38%

- Sound effects are simple.

## GRAB FACTOR ..... 86%

- The icon system is much better than random capsules.
- Unoriginal game concept.

## STAYING POWER ..... 78%

- The difficulty factor increases slowly to keep you interested.
- 80 levels to master and you can also design your own.

## AA RATING ..... 81%

- Good fun to play even if it does lose out on originality.

GBH

## FIRST DAY TARGET SCORE

Complete 10 levels

# COMSOFT SUPER SAVER SALES 20% DISCOUNT

Offer ends July 31st 1988

Detail of Goods	Cass R.R.P	Sale Price	Disc R.R.P	Sale Price	Cass R.R.P	Sale Price	Disc R.R.P	Sale Price
6 Pak	9.95	7.96	14.95	11.96	9.99	7.99	14.99	11.99
720	9.99	7.99	14.99	11.99	8.95	7.16	14.95	11.96
Academy	9.95	7.96	14.95	11.96	-	0.00	19.95	15.96
Ace	9.99	7.99	14.99	11.99	9.95	7.96	14.95	11.96
Ace of Ace	9.99	7.99	14.99	11.99	9.99	7.99	14.99	11.99
Acrojet	9.95	7.96	14.95	11.96	8.95	7.16	-	0.00
Activator	8.95	7.16	13.45	10.76	8.95	7.16	13.95	11.96
Aliens (Electric)	9.99	7.99	14.99	11.99	8.95	7.16	-	0.00
Aliens (U.S Version)	9.99	7.99	14.99	11.99	9.95	7.96	14.95	11.96
All New Blockbuster	7.95	6.36	14.95	11.96	9.95	7.96	14.95	11.96
Andy Cap	9.95	7.96	14.95	11.96	9.99	7.99	14.99	11.99
Annals of Rome	12.95	10.36	17.95	14.36	9.99	7.99	14.99	11.99
Arkanoid	8.95	7.16	14.95	11.96	8.95	7.16	14.95	11.96
Armageddon Man	12.95	10.36	-	0.00	14.95	11.96	19.95	15.96
Barbarian	9.99	7.99	12.95	10.36	9.99	7.99	-	0.00
Barry McGuigan World Boxing	-	0.00	14.99	11.99	9.99	7.99	14.99	11.99
Basket Master	8.95	7.16	14.95	11.96	14.95	11.96	19.95	15.96
Basil Great Detective	9.99	7.99	14.99	11.99	9.99	7.99	14.99	11.99
Battle for Midway	-	0.00	9.95	7.96	9.95	7.96	14.95	11.96
Battle of Britain	-	0.00	9.95	7.96	9.95	7.96	14.95	11.96
Battle of Germany	12.95	10.36	17.95	14.36	4.99	3.99	9.99	7.99
Big 4 Compilation	9.95	7.96	11.95	9.56	-	0.00	14.99	11.99
Big 4 Vol. 2	9.95	7.96	14.95	11.96	9.95	7.96	14.95	11.96
Blue War	-	0.00	14.99	11.99	9.95	7.96	14.95	11.96
Bobsleigh	9.95	7.96	14.95	11.96	9.99	7.99	14.99	11.99
Bombjack 2	8.95	7.16	14.95	11.96	8.95	7.16	14.95	11.96
Book of the Dead	8.95	7.16	14.95	11.96	9.95	7.96	14.95	11.96
Boulderdash Construction Set	9.95	7.96	14.95	11.96	9.99	7.99	14.99	11.99
Brave Starr	9.99	7.99	14.99	11.99	9.99	7.99	14.99	11.99
Brian Clough Football	14.95	11.96	17.95	14.36	9.99	7.99	14.99	11.99
Buggy Boy	9.95	7.96	14.95	11.96	8.95	7.16	14.95	11.96
Bulls Eye	7.95	6.36	-	0.00	9.95	7.96	14.95	11.96
California Games	9.99	7.99	14.99	11.99	9.95	7.96	14.95	11.96
Captain America	9.99	7.99	14.99	11.99	9.99	7.99	14.99	11.99
Cassette 50	9.95	7.96	-	0.00	9.95	7.96	14.95	11.96
Chamonix Challenge	9.95	7.96	14.95	11.96	9.99	7.99	14.99	11.99
Championship Football	9.99	7.99	14.99	11.99	9.99	7.99	14.99	11.99
Cleaver + Smart	9.99	7.99	14.99	11.99	8.95	7.16	14.95	11.96
Cleodo	9.95	7.96	14.95	11.96	-	0.00	19.95	15.96
Colossus Bridge	11.95	9.56	14.95	11.96	12.95	10.36	17.95	14.36
Colossus Chess 4	9.95	7.96	13.95	11.16	8.95	7.16	14.95	11.96
Colossus Mah Jong	9.99	7.99	14.99	11.99	8.95	7.16	14.95	11.96
Combat School	8.95	7.16	14.95	11.96	7.99	6.39	9.99	7.99
Compendium	9.99	7.99	14.99	11.99	8.95	7.16	13.45	10.76
Computer Hits 10	9.95	7.96	-	0.00	9.99	7.99	14.99	11.99
Computer Hits 2	9.95	7.96	14.95	11.96	9.99	7.99	14.99	11.99
Computer Hits 3	9.95	7.96	14.95	11.96	8.95	7.16	14.95	11.96
Computer Hits 4	9.95	7.96	14.95	11.96	9.99	7.99	14.99	11.99
Computer Hits 5	6.95	5.56	11.95	9.56	9.99	7.99	14.99	11.99
Computer Hits 6	-	0.00	14.95	11.96	7.95	6.36	11.95	9.56
Conflicts	12.95	10.36	17.95	14.36	9.95	7.96	14.95	11.96
Countdown	7.95	6.36	-	0.00	9.95	7.96	14.95	11.96
Dandy	9.99	7.99	14.99	11.99	9.95	7.96	14.95	11.96
De Luxe Scrabble	-	0.00	15.95	12.76	9.95	7.96	14.95	11.96
Death or Glory	8.95	7.16	14.95	11.96	9.99	7.99	14.99	11.99
Death Wish 3	9.99	7.99	14.99	11.99	9.95	7.96	14.95	11.96
Deeper Dungeons	-	0.00	8.99	5.99	14.95	11.96	19.95	15.96
Defektor	9.99	7.99	14.99	11.99	9.99	7.99	14.99	11.99
Disc 50	-	0.00	14.95	11.96	12.95	10.36	17.95	14.36
Dragons Lair	8.95	7.16	14.95	11.96	9.95	7.96	14.95	11.96
Dragons Lair 2	8.95	7.16	14.95	11.96	9.99	7.99	-	0.00
Driller	14.95	11.96	17.95	14.36	14.95	11.96	19.95	15.96
Druid	7.95	6.36	12.95	10.36	9.95	7.96	14.95	11.96
Elite	9.95	7.96	14.95	11.96	9.99	7.99	14.99	11.99
Elite Collection	17.95	14.36	19.95	15.96	9.99	7.99	14.99	11.99
Enduro Racer	9.99	7.99	14.99	11.99	9.95	7.96	14.95	11.96
Epyx on Amstrad	9.99	7.99	14.99	11.99	9.99	7.99	-	0.00
Evening Star	8.95	7.16	14.95	11.96	8.95	7.16	14.95	11.96
Eylon	8.95	7.16	14.95	11.96	9.95	7.96	14.95	11.96
F A Cup Football 87	7.95	6.36	-	0.00	9.95	7.96	14.95	11.96
F15 Strike Eagle	9.95	7.96	14.95	11.96	9.95	11.74	14.95	17.64
Firetrap	9.99	7.99	14.99	11.99	9.95	7.96	14.95	11.96
Five Star Games	9.95	7.96	14.95	11.96	9.99	7.99	14.99	11.99
Five Star Games 2	9.95	7.96	14.95	11.96	8.95	7.16	13.95	11.16
Five Star Games 3	9.95	7.96	14.95	11.96	14.95	11.96	19.95	15.96
Football Director	8.95	7.16	-	0.00	14.95	11.96	19.95	15.96
Footballer of the Year	9.95	7.96	14.95	11.96	14.95	11.96	19.95	15.96
Four Smash Hits	8.95	7.16	14.95	11.96	-	0.00	6.99	5.59
Frankenstein	8.95	7.16	14.95	11.96	9.95	7.96	-	0.00
Freddy Hardest	8.95	7.16	14.95	11.96	9.95	7.96	14.95	11.96
G Gooch Test Cricket	9.95	7.96	14.95	11.96	9.95	7.96	14.95	11.96
Galactic Games	9.99	7.99	14.99	11.99	9.99	7.99	14.99	11.99
Game Set and Match	12.95	10.36	17.95	14.36	9.99	7.99	14.99	11.99
Gameover	8.95	7.16	14.95	11.96	9.99	7.99	14.99	11.99
Gary Linekers Football	9.99	7.99	14.99	11.99	9.95	7.96	14.95	11.96
Gauntlet	9.99	7.99	14.99	11.99	14.95	11.96	19.95	15.96
Gauntlet 2	9.99	7.99	14.99	11.99	9.95	7.96	14.95	11.96

SEND FOR OUR CATALOGUE OF OVER THREE THOUSAND TITLES FOR AMSTRAD CPC - PCW - PC, COMMODORE, SPECTRUM, ATARI/ATAI ST, BBC, MSX, APPLE SERIES 2 - APPLE MACINTOSH COMPUTERS, ALL AT DISCOUNT PRICES

All Prices include V.A.T Post and Packaging UK only.

COMSOFT MAIL ORDER DEPT, 48 DUKE STREET, COLDSTREAM, BERWICKSHIRE TD12 4LF

Shop open Mon-Sat 9.30 - 12.00, 1.00 - 5.30 Tel:0890 2979.

VISA

24-Hour order service on 0890 2854

## At last the real McCoy FOOTBALL DIRECTOR

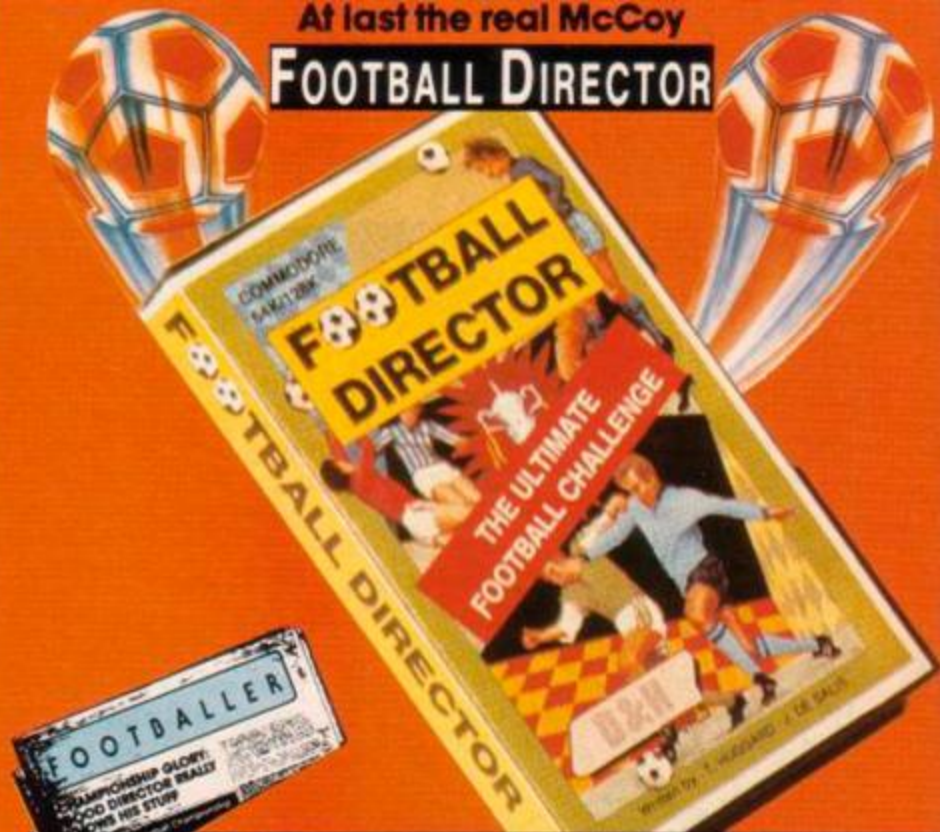

### THE MOST REALISTIC FOOTBALL STRATEGY GAME YOU CAN BUY

AVAILABLE FROM ALL LEADING RETAILERS

#### FEATURES

- Four Leagues
- 20 Teams each
- 38 Game Season
- Home + Away
- FA/League Cup
- Replays - European Cup
- Out Run
- Paperboy
- Pawn
- Pegasus Bridge
- Phantom Club
- Psycho Soldier
- Pub Games
- Questor
- Rampage
- Ramparts
- Renegade
- Road Runner
- Rygar
- Saboteur 2
- Scalextric
- Scrabble
- Scraples
- Sentinel
- September
- Silent Service
- Silicon Dreams
- Solid Gold
- Sorcerer Lord
- Spiffire 40
- Star Games 2
- Stargider
- Strike Force Harrier
- Super Hang On
- Super Sprint
- Sword and Sorcery
- Ten Great Games
- They Sold A Million
- They Sold A Million 2
- They Sold A Million 3
- Thundercats
- Tobruk
- Trantor
- Trap Door 2
- Trivial Baby Boomer
- Trivial Genius Edit
- Trivial Young Edit
- Ultima Ratio/Gunstar
- Vulcan
- Western Games
- Winter Games
- Wonderboy
- World Class L Board
- World Games
- Xor
- Yes Prime Minister
- Yogi Bear

- Name Editor
- Team Editor
- LATC Counter
- League Titles
- Sackings
- Extra Training
- Insurance
- Build Stands
- Pools Panel
- Manager of the Month
- MUCH MORE
- FEATURES VARY WITH DIFFERENT COMPUTERS

ORDER A COPY TODAY

#### SPECTRUM SCREENSHOTS

TIME 98 MIN FULL TIME AWAY

NOTTS FOR (1)3 DERBY C (0)1

SUTTON 24 MIN HILLS 66 MIN

WALLACE 63 MIN

HUNT 77 MIN

---

EUVERTON 3 PLYMOUTH 0  
ASTON V 0 BRIGHTON 0  
WEST HAM 0 OLDHAM A 0  
MAN UTD 0 TOTTENHAM 0  
CRYSTAL P 0 BARNLEY 0  
LIVERPOOL 0 CHARLTON 0  
LEEDS UTD 0 NORWICH C 0  
NEWCASTLE 0 ARSENAL 0  
SOUTHPTON 0 BRMINGHAM 0

C CONTINUE

URG BILL WEEKLY NEWS GATE MONEY

£11695- £36718+

GENERAL RUNNING COSTS £23720 -

INTEREST FROM BANK £729 +

MURRAY TESTIMONIAL £61271 +

CROWD VIOLENCE: DAMAGES £98728 +

SPONSORS PAY THE CLUB £61271 +

TV LIVE BROADCAST NETS £20000 -

BANK REPAYMENTS £8325 -

MORTGAGE REPAYMENTS £28358 -

WEEKS PROFIT £-11738 -

SCOUT LOOK AT TRANSFER MARKET

CLOUGH INJURED FOR 2 WEEKS

THE PLYMOUTH MANAGER APPROACHES YOU AND OFFERS £778456 AND WALKER IN A FREE TRANSFER FOR WEBB DO YOU ACCEPT Y/N

BANK £243064

SEASON 14 M MENU

REVENUES

ASTON V 0 BRIGHTON 0  
WEST HAM 0 OLDHAM A 0  
MAN UTD 0 TOTTENHAM 0  
CRYSTAL P 0 BARNLEY 0  
LIVERPOOL 0 CHARLTON 0  
LEEDS UTD 0 NORWICH C 0  
NEWCASTLE 0 ARSENAL 0  
SOUTHPTON 0 BRMINGHAM 0

SEASON 14 M MENU

GOALS

HUNT 77 MIN  
WALLACE 63 MIN  
SUTTON 24 MIN  
HILLS 66 MIN

SEASON 14 M MENU

INJURIES

CLOUGH INJURED FOR 2 WEEKS

SEASON 14 M MENU

1st TEAM RESERVES

HUNT 77 MIN  
WALLACE 63 MIN  
SUTTON 24 MIN  
HILLS 66 MIN

SEASON 14 M MENU

NOTTS FOR 8 MANICH

GOALKEEPER 0 DEFENCE 0 MIDFIELD 0 ATTACK 0

EUROPEAN CUP WINNERS CUP QUARTER FINAL

2nd LEG AGG 1-2

SEASON 14 M MENU

11772

HIRE YOUTH TEAM £362 P/W

BACK COACH STAFF SALARIES £200 P/W

BACK PHYSIO

BACK SCOUT

INFORM SCOUT OF PLAYER UNITED CURRENTLY SEEKING 0 5

FOR 0 ENTER 1  
ENTER 2  
ENTER 3  
ENTER 4

CURRENT FORMY BANK £243064

SEASON 14 M MENU

SPECTRUM £8.95 • COMMODORE £8.95 • AMSTRAD £8.95

This game also available by mail order at £8.95 per cassette. Send your cheque/ P.O. made out to D & H Games plus a large SAE, with 25p stamp attached. Please write your name and address on reverse side of cheque. (72 hours delivery).



19, Melne Road, Stevenage, Herts SG2 8LL  
(0438) 728042

## BLOOD BROTHERS

Gremlin, £9.99 cass, £14.99 disk, joystick or keys

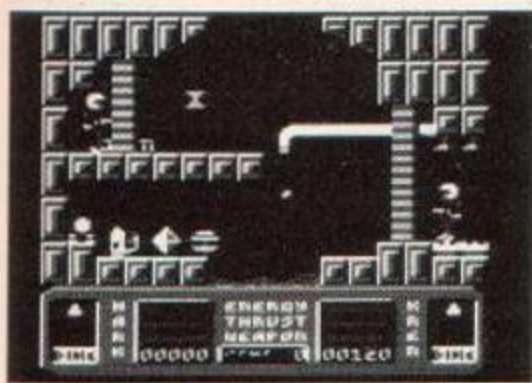

Hark and Kren go Scorpion slaying

Hark and Kren are brothers that have just passed their examinations in laser technology and hi-tech control. Their parents bought them jetbikes for the high grades they got. While the boys are out, some space pirates have attacked their village, stolen all the gems and killed everyone. Hark and Kren want revenge.

One or two people can play simultaneously, and it does work much better as a two player game. In the solo game you can switch between which of the brothers you control. There are two main stages to the game and three different blocks of code that can be loaded in. One stage is a side view of the mines of Scorpia and the other is the planet surface with a brother in his jetbike. The mines are a flick screen game and the jetbike sequence is a 3D-perspective flying sequence.

The mines are made up of a labyrinth of tunnels, all filled with hostile beings that do their utmost to kill you. As well as the aliens that shoot back at you there are deadly pools of water lying in some rooms. Extra fuel and weaponry can be found in the mines, as can the gems stolen from the village. During the mine stage the two players can swap energy, fuel and firepower by touching each other. In the jetbike sequence you have to fly around avoiding or shooting the blocks that get in the way, in an attempt to find other mine entrances. This stage is particularly difficult to control until you've practiced a lot. The graphics are all very colourful and smoothly animated. A futuristic tune plays on the title screen, but there are none in the game. Sound effects are typical shoot-em-up - loud and zappy.

### SECOND OPINION

*A game that's just a little bit tough for one person to handle. I daresay someone will manage it, but playing with a friend is so much easier, plotting and planning your next moves. The jetbike sequence is also on the tricky side. Graphically it moves smoothly enough, but personally I'd like a little more control.*

PbM

### GREEN SCREEN VIEW

*Everything's easy to identify in green*

As a two player game it's great fun, but the single player option is a little tricky to handle and hence it's much more difficult to complete. The searching and blasting aspects have been mixed well to produce an enjoyable, if unoriginal game.

GBH

### FIRST DAY TARGET SCORE

1,000 points

### The Verdict

**GRAPHICS** ..... 82%

- Smoothly animated sprites.
- Brightly coloured scenery.

**SONICS** ..... 43%

- Nice title tune.
- Typical shoot-em-up effects.

**GRAB FACTOR** ..... 67%

- Two player game is more entertaining.
- As a one player it's too difficult.

**STAYING POWER** ..... 58%

- Three different areas can be loaded in.
- Repetitive gameplay.

**AA RATING** ..... 62%

- Definitely best as a game for two.

## GEEBEE AIR RALLY

Activision, £9.99 cass, £14.99 disk, joystick or keys

In the 1930's the Geebee speed plane was very popular amongst the braver (or stupider) pilots. It was very fast, very ugly and lethal, to the pilot that is. It looked like an apple barrel, moved like the wind and steered like a cow.

You're under starter's orders in a race against time and other aircraft, for the prestigious Cartwright Cup. 100 miles of race lies before you, divided into four courses and eight levels. In the first three courses you negotiate a

### The Verdict

**GRAPHICS** ..... 39%

- Flickery graphics.
- Gives little impression of movement.

**SONICS** ..... 48%

- Reasonable tunes.
- Lousy sound effects.

**GRAB FACTOR** ..... 47%

- You can really throw the GeeBee around.
- There aren't enough hazards or tasks.

**STAYING POWER** ..... 36%

- Eight levels of increasing difficulty.
- They're all basically the same.

**AA RATING** ..... 39%

- Old programming techniques used in a game with too little variation.

### SECOND OPINION

*Oh Yawnsville City, Arizona. There's so little in this one to get you hooked. The flying is OK in itself but there's nothing to do once you're up there. Just doesn't excite the blood at all.*

BW

### GREEN SCREEN VIEW

*It looks just as bad and is just as easy to play in green.*

course of markers and avoid other aircraft. If you don't finish the course within the time limit then you'll have to go again. Fail a second time and you'll be out of the game. If you collide too often then you'll have to bail out.

The fourth stage is a balloon bursting race where points are awarded for balloons burst. Pylons have to be avoided or you'll end up bailing out again. After this stage you go to the next level and things get a bit more difficult.



What happens if you crash

Apart from the pretty pictures that you get when you bail out the graphics are poor. The landscape scrolling is done simply by moving coloured bars on the ground to give an impression of movement. The markers and plane flicker too, making the overall impression that of a rush job conversion. Although there's a tune on the title screen it's not much good and neither is the tune for bailing out. The effects in the game are feeble engine hums.

The difficulty level of this is set far too low, you'll probably complete the game within a week. As well as that there's the simple fact that it's boring, all you do is dodge about a bit, there's nothing else to it.

GBH

### FIRST DAY TARGET SCORE

Complete level 3.

## KARNOV

Electric Dreams, £9.99 cass, £14.99 disk, joystick or keys

The evil wizard Ryu, better watch out, because there's a flamethrowing Russian headed in his direction. Karnov is that Russian and wizard bashing is not all he's after, there's also the lost treasure of Babylon that was taken by Ryu.

Across the bottom of the screen is a row of icons that are initially empty, but you'll get an opportunity to fill them later. The time left is also displayed there and at the top of the screen your score is shown. The rest of the screen is taken up with a four way scrolling playing area, in which you will encounter the minions of Ryu.

### SECOND OPINION

*Why haven't software houses got the message about restart points yet? It is infuriating to get through hordes of monsters, only to make a mistake and get sent way back down the level. That's the main problem with what is otherwise a reasonable arcade game, full of lots of action and challenges.* **BW**

### GREEN SCREEN VIEW

*You can see everything clearly in green.*

Big bird like creatures, ostrich riding skeletons, sword wielding figures in robes and rock throwers are some of the foes that you will encounter. Collision with them loses you a life, extra lives are gained by collecting letter K's.

There are 10 items that you can collect other than the K's and they are: apples, boots, bombs, ladders, boomerangs, flames, wings, helmet, mask and trolley. Apples increase your firepower for extra destructive power. The other nine appear as icons at the bottom of the screen. The boots give you more powerful leaps and a faster movement rate. Bombs can be used to blow anything up and the lad

### The Verdict

**GRAPHICS** ..... 46%

- Poor four way scrolling.
- Lacking in colour and variety.

**SONICS** ..... 38%

- No tunes.

**GRAB FACTOR** ..... 56%

- Fairly easy to grasp what's going on and get blasting.
- If you lose a life in the wrong place it can be impossible to continue.

**STAYING POWER** ..... 43%

- Level after level of progressively more difficult problems.
- Another boring kill the monsters game.

**AA RATING** ..... 50%

- Poor graphics and frustrating gameplay.

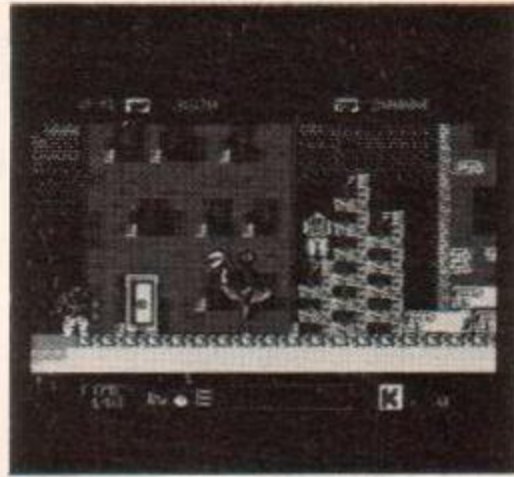

● Karnov spits fire at ostriches

der gets you climbing up the screen. If you throw a boomerang, don't forget to catch it.

Sound effects are average, the best being the lightning bolt from which you materialize, and tunes are non-existent. The graphics lack colour and the scrolling is not particularly smooth. Animation is very jerky too and at times there is flicker.

It's another in the long line of scrolling shoot-em-ups where you charge around on legs instead of flying a space ship. The multi-load facility does enable it to have many levels, but at the end of the day it's nothing new. **GBH**

**FIRST DAY TARGET SCORE**

12,000

## LAZER TAG

GO, £9.99 cass, £14.99 disk, joystick or keys

Lazer Tag is a game in which each player has a gun that fires a low powered infrared beam and they also wear a sensor that detects the beam. When you take six hits you're out the game. The winner being the last player alive.

The computer version is set in the distant future when the worlds' desire for violent sports has been replaced by the harmless game of shooting each other with lasers (1?).

### SECOND OPINION

*This is a fairly simple offering that has been competently programmed and is reasonably enjoyable. It won't get your adrenalin pumping because it's a war of attrition. However it gets tough later on, even if the action is very predictable.* **BW**

### GREEN SCREEN VIEW

*Everything's visible.*

There are two stages to the game itself: shooting and target. In shooting you just have to reach the end of level in a time limit and take as few hits as possible. There are lots of other players out to shoot you and since you can only take six hits you have to be careful.

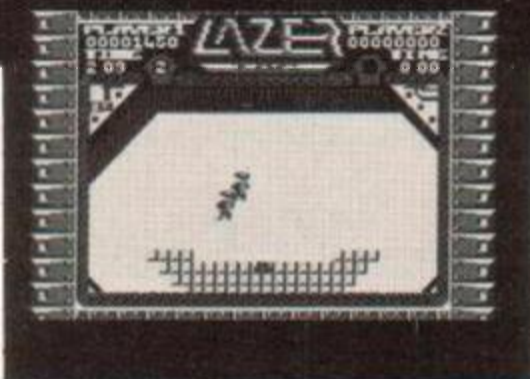

● You're the tiny little man in blue shooting the other little men in blue

Bonus lives and equipment can also be picked en route to the end of level.

Stage two is a target shoot where you will be awarded bonus points for accuracy. Of course there are still other people out there trying to shoot you. After this stage you progress up to the next rank and go back to shooting.

A tolerable tune plays on the title screen and another plays throughout the game. Sound effects are beeps and pings. The vertical scrolling is smooth but slow, and the sprites are tiny. Animation is poor too.

Lazer Tag the game may be a fun pastime to while away the hours, but the computer game is a feeble attempt at cashing in on it.

You're better off saving the money and putting it towards a Lazer Tag gun. **GBH**

**FIRST DAY TARGET SCORE**

10,000 points

### The Verdict

**GRAPHICS** ..... 46%

- Smooth vertical scrolling.
- Poor animation and use of colour.

**SONICS** ..... 53%

- Tolerable tunes.
- Tinny effects.

**GRAB FACTOR** ..... 44%

- You wander around shooting and...
- then you wander around shooting things again.

**STAYING POWER** ..... 39%

- Plenty of ranks to build up through.
- Not much variation from rank to rank.

**AA RATING** ..... 41%

- Save your money for the real thing.

## THE RACE AGAINST TIME

Codemasters, £4.99 cass, joystick or keys

Two things make this game stand out before you even open the box. The first is that all profits from it will go to Sport Aid '88, and the other is that it has the music from the Peter Gabriel track *Games without Frontiers* as the soundtrack. It may not be the first charity game, but it is the first to have Gabriel's music on it. Charity games in the past have always been re-releases of old titles or compilations, but this time the game has been written specifically for the charity by the Oliver twins.

### SECOND OPINION

*I don't really think you can class this as an arcade adventure because there are relatively few problems to solve and it's more a matter of exploration than anything else. However, bung in a tight time limit and you've got a competent game that induces panic gameplay.*

BW

### GREEN SCREEN VIEW

No problems.

Play begins in a relief camp in Sudan where you are holding a torch. Your first task is to find the airport, which is easy, and then jet off to one of the six continents. It's an arcade adventure in which you have to raise a flag and light a flame in all the continents.

It's not so simple to complete because you have various problems to solve to get to the destinations. Don't get wet under any circumstances, because the flame will be extinguished and the game will end.

### The Verdict

**GRAPHICS** .....64%

- Well animated sprites and detailed scenery.
- Not much colour.

**SONICS** .....43%

- Digitised speech.
- Games Without Frontiers* is terrible.

**GRAB FACTOR** .....54%

- Lots of exploration to do early on.
- Only having one life is enormously frustrating.

**STAYING POWER** .....64%

- Plenty of problems to solve.
- 100 locations to explore.

**AA RATING** .....68%

- It's all in a good cause.



● One flag raised, only five more to go

Each of the 100 locations is well drawn, but unfortunately there's not much colour used. Animation of the sprites is good and there's no flicker. As far as sound effects go they are simple and ineffective. As for the speech digitising, either the Oliver twins are getting better at it or I'm getting used to it, because it was easier to understand this time. The less said about the *Games without Frontiers* soundtrack the better, because it's only just identifiable as the same track.

The problems seemed easier to solve than those you normally get in arcade adventures, but that's not really a bad point because some of the problems in recent games have been very illogical. Fans of arcade adventures will find plenty to keep them occupied. GBH

### FIRST DAY TARGET SCORE

Raise three flags or light three flames.

## EYE

Endurance, £9.95 cass, £14.95 disk, joystick or keys

Now we can all give the once over to the computer version of the popular boardgame. The game is for two to four players, any of which can be computer controlled. Each player has some counters that you place on the board. The board is made up of 32 coloured squares formed from two spirals within a circle. There are eight different colours and each has four squares in view at any one time.

Depending on how many players there are, you start with six, four or three counters of your chosen colour. Each player takes it in turn to place counters on the board. When all are in play it goes into the second stage of the game. Here the number of moves that you get is dependent on how many squares of the same colour you occupy. This can range from one to four. If you occupy four of the same colour you gain control of that colour which means that you can throw anyone else's counters off if they go on that colour.

● Mind stretching strategies for up to four people

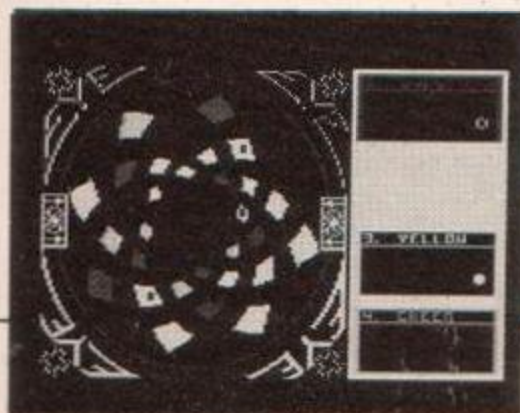

The concept is simple, all you have to do is get a number of coloured counters on squares of the same colour. Actually achieving this end is not so easy because not only are there other players out there trying to win, but the spirals on the board can be rotated. There are four winning patterns: a long spiral, short spiral, straight line and a circle.

The only sound that you get is a beep and there are no tunes. The graphics are bright and colourful, although the counters are a bit small.

### SECOND OPINION

*I'm not a fan of board games converted onto computers because they hardly ever make use of the computer's talents. This is no exception, even though it is a pretty good game. The only advantage is being able to play on your own against the computer.*

BW

### GREEN SCREEN VIEW

*Distinguishing the colours is tricky in green.*

First impressions are often misleading and this is a classic example. The first few games that you play you won't know what on earth is going on, but after that you'll get to grips with it. It's the sort of game that you play again and again and still learn something

### The Verdict

**GRAPHICS** .....56%

- Colourful board.
- Bad news for green screen owners.

**SONICS** .....26%

- Absolutely hopeless.

**GRAB FACTOR** .....60%

- Lots of tactics and depth to get involved with.
- Very confusing to begin with.

**STAYING POWER** .....68%

- Demanding computer opponent at first...
- but after a while you'll only find it a challenge against other players.

**AA RATING** .....63%

- It's unusual for a board game to convert well to a computer, but this is a pleasant exception.

new each time. If you want a game to warp your mind then have a look at this. GBH

### FIRST DAY TARGET SCORE

Defeat the computer in the two player game.

**STREETFIGHTER**

GO, £9.99 cass, £14.99 disk, joystick or keys

From the programmers of *Rolling Thunder*, *720* and *Indiana Jones* comes a conversion of the Capcom coin-op game of martial arts.

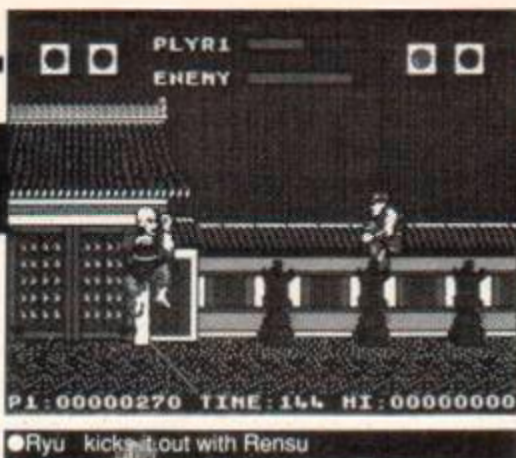

**The Verdict**

**GRAPHICS** ..... 58%

- Detailed backgrounds and characters.
- Lacks colour.

**SONICS** ..... 23%

- Nice effects, but there aren't many.

**GRAB FACTOR** ..... 57%

- Challenging and entertaining to begin with.
- Un original - just another combat game.

**STAYING POWER** ..... 43%

- Ten different opponents of increasing difficulty.
- Once you've beaten them all there's nothing left to do.

**AA RATING** ..... 51%

- You'd think people had had their fill of this kind of stuff.

Travel the world in an attempt to become the worlds greatest streetfighter.

The screen shows one of five different backdrops and in the foreground are two figures. Above the playing area is a bar that shows how much energy each fighter has and two indicators inform you of how many rounds each fighter has won.

Combat takes place in five different countries and there are two opponents per country. The countries are: Japan, USA, UK, China and

**SECOND OPINION**

*There really is nothing new here at all, just more beat-em-up action. It offers reasonably good increasing difficulty but otherwise it isn't anything we haven't seen a dozen times before.* **BW**

**GREEN SCREEN VIEW**

*Clearly visible in green.*

Thailand. To go on to the next opponent you must win two of the three rounds of combat. As with most other combat games you have a variety of different moves that can be used to defeat your opponents.

To win a fight you have to reduce your opponents energy to zero and then bonus points are awarded according to how much time is left and how much energy you have remaining. After beating two opponents you go to a bonus stage where you have to smash a pile of tiles. Play then moves to another country and the opponents get tougher.

Graphics are lacking in colour, but the animation of the fighters is reasonable. The backgrounds scroll left or right if you move near to the edge of the screen. Sound is limited to simple fighting effects.

Martial arts programs seem to have been around forever and they have got stuck in a rut. All you get now is some different graphics and perhaps some tougher opponents. There's nothing wrong with this if you're in the mood for some mindless beat-em-up action. **GBH**

**FIRST DAY TARGET SCORE**

Get to China.

**SOCCER 6128**

Graeme McQuoid, £8.00 disk, 6128 only, keys only

Football strategy games have been going for a long time and until now *Big League Soccer* and *Football Director* have been the best. This one takes advantage of the extra memory of the 6128 and so it won't run on the 464 or 664.

All of the game options are accessed through a series of menus and sub menus. The options are accounts, buy players, sell players, fixtures, help, league programme, match, opposition, playing staff, save game and table. Accounts gives you information on players wages, gate incomes and other incomes and expenditures. The buy and sell player options speak for themselves, but this is one area where this game is different from previous ones because there are 2000 players in all, divided between the 80 English clubs and 60 European.

Your side and the formation can be altered using the playing staff option and information on your opponent is gained from the opposition option. The league shows how well you're doing. Help provides you with instructions on how to play.

You then get an overhead view of the pitch with little crosses to represent the players. The ball is passed from player to player

and time ticks away at the top of the screen.

Graphics and sound are where this falls down very badly, the match highlights are hopeless and the sound is not much better. Colour is used well on the menus though.

The price of eight pounds on disk is due to the fact that there is little packaging and the instructions are on the game disk, they can



● The match highlights

however be printed out if you have a printer. The strategy element is fine, it's just a pity that more effort wasn't put into presentation. **GBH**

**FIRST DAY TARGET SCORE**

Come top of the division.

**SECOND OPINION**

*The graphics and sound may be dreadful but the strategy and thoroughness of the game are excellent. It rivals Big League Soccer and Football Director in this department and will provide endless hours of football fun. It's a shame it's in Basic and therefore pretty easy to crash, but that's a minor criticism. It's even a cheap disk game - something of a rarity.* **BW**

**GREEN SCREEN VIEW**

*Looks ok in green and is easily readable.*

**The Verdict**

**GRAPHICS** ..... 12%

- Diabolical match highlights.
- No other graphics at all.

**SONICS** ..... 07%

- A whistle and a beep is all that you get.

**GRAB FACTOR** ..... 52%

- One of the most realistic football strategy games to date.
- A choice of starting division.

**STAYING POWER** ..... 63%

- All league and European trophies.
- Not very well error trapped.

**AA RATING** ..... 66%

- A challenging management game, that is let down a little by presentation.

Soccer 6128 is only available by mail order from: Graeme McQuoid, 32A Albert Street, Seaham, County Durham, SR7 7LJ

**NO 1 BEST SELLING  
COMPILATION PACK**

# THE ARE THE

# CHAMPIONS

**ALL THESE CHART TOPPING HITS**



#### RENEGADE

In the knife-edge world of the vigilantes there is no place to rest, no time to think - but look sharp - there is always time to die! You will encounter the disciples of evil whose mission it is to exterminate the only man on earth who dares to throw down the gauntlet in their path - the Renegade. **PLAY RENEGADE... PLAY MEAN!**  
Licensed from © Taito Corp., 1986.

#### IK+

They called International Karate 'the greatest Karate beat 'em up yet' (Commodore User). And who are we to argue? But ARCHER MACLEAN has come up with a stunner: A third fighter. An amazing animated background. New moves (including double head-kick and a spectacular backflip). Re-mixed music by BOB HUBBARD. And balls!  
© 1987 Archer Maclean. © 1987 System 2 Software Ltd.

#### SUPER SPRINT

Licensed from Atari Games' original money-spinning coin-up, one or two players compete head-to-head over eight grueling tracks and four levels of game difficulty. Avoid the hazards and collect golden spanners to enhance custom car features - the key to Super Sprint. With detailed animation and sound effects, Super Sprint brings the best driving excitement ever to be experienced on home computers.  
TM & © Atari Corporation 1986.  
All Rights Reserved.  
© Electronic Dreams Software 1987.

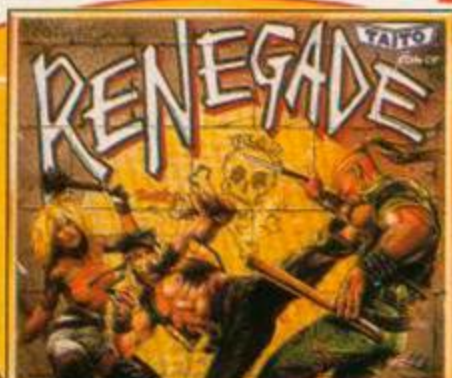

#### RAMPAGE

The game where the nice guys don't get a look in. Grab your way through Chicago, punch up New York, and jump on San Francisco. Three indescribably nasty characters which bear a remarkable likeness to King Kong, Godzilla and Wolf-man, need you to send them on a rampage in an enduring 150 days of destruction, through 50 different cities.  
TM & © 1986 Bally Midway MFG Co.  
All rights reserved. Activision Inc.

#### BARBARIAN

**THE STORY SO FAR...**  
The evil sorcerer Drax has sworn to wreak an unspeakable doom on the people of the Jewelled City unless Princess Marissa is delivered to him. However, he has agreed that if a champion can be found who is able to defeat his demonic guardians, the Princess will be released. From the wastelands of the North, comes an unknown barbarian, a mighty warrior, wielding his broadsword with deadly skill. Can he vanquish the forces of Darkness and free the Princess?  
**ONLY YOU CAN SAY...**  
© Peace Software 1987.



**IN A SINGLE GIANT PACK**

ONLY  
**£9.95**  
EACH

**ocean**

**OUT NOW!**

# ROMANTIC ROBOT present

## 1988 - THE YEAR OF THE ROBOT



**Q: WELL, I'VE HEARD OF THE YEARS OF THE CAT, PIG, AND EVEN DRAGON - BUT THE YEAR OF THE ROBOT?**

**A:** Absolutely! And ROMANTIC ROBOT wish to make 1988 a truly memorable year (if not us, who will?). To kick off with, there is an INTRODUCTORY OFFER OF **£29.88** ON RODOS, plus a truly unique 1988 SPRING MAIL ORDER PRICE OF MULTIFACE TWO - **£42.88**

**Q: I LOVE SALES. BUT WHAT'S SO LIKEABLE ABOUT RODOS and MULTIFACE?**

**A:** RODOS is too powerful and complex to be summed up here - please send a SAE for full info. MULTIFACE is (simply) a MUST for ANY CPC owner: it can copy and change programs as you wish.

**Q: OH, DO I NEED TO DO ANY PROGRAMMING TO MAKE BACK-UPS?**

**A:** NO! - NOT with the MULTIFACE TWO - it is in fact the ONLY product on the market which works FULLY AUTOMATICALLY. You LOAD any program as usual, RUN it for as long as you like and when you wish to make a copy you just press the MULTIFACE's red button and follow the menu and on-screen instructions.

**Q: HOW DOES IT WORK THEN? IS IT EASY? USER-FRIENDLY? ERROR-TRAPPED? IDIOT PROOF? GUARANTEED?**

**A:** YES! It works a treat and it could not be easier. The menu gives four basic options - to **SAVE** a program, to **RETURN** to continue it, to **JUMP** (say to your own routines - invaluable for hackers) and **TOOL** to access the MULTI-TOOLKIT set of built-in utilities. For example pressing **S** to **SAVE** will first allow you to **NAME** the back-up and then let you save a **PROGRAM** or just a **SCREEN TO TAPE** or **DISK**. Before the saving itself, MULTIFACE compresses the program so that it takes the least amount of space on tape/disk and will re-load as quickly as possible. Once a program is saved, you can **RETURN** or **JUMP**, use the **TOOLKIT** to change it, **SAVE** it again, etc.

**Q: DON'T YOU CORRUPT THE SCREEN WITH YOUR MENU, INSTRUCTIONS, PULL DOWN WINDOWS, ETC.?**

**A:** NO. MULTIFACE TWO has its own memory (8K ROM & 8K RAM) and a lot more hardware - thus when it finishes its job or when you re-load your back-ups, everything is **FULLY** and **AUTOMATICALLY** restored: screen modes, colours, windows, etc. This is essential and **NO OTHER DEVICE CAN DO IT!**

**Q: OK, SO MULTIFACE CAN COPY FROM TAPE TO DISC, BUT CAN IT DO TAPE TO TAPE OR DISC TO DISC OR DISC TO TAPE?**

**A:** Of course it can. MULTIFACE saves either to tape or disc and it saves whatever happens to be in the computer at that time - no matter how you loaded it in.

**Q: SO FAR SO GOOD, BUT CAN'T I DO ALL THIS WITHOUT THE MULTIFACE?**

**A:** ABSOLUTELY NOT! First, you need a hardware device, a "magic box", to be able to stop and copy programs AT ANY STAGE - be it upon loading, half-way through the game, etc. Tape/disc copiers can only try to copy programs BEFORE they load: if there are unorthodox loaders, speedlocks, protections against copying, etc., you'll end up with a problem - but not with a back-up. Also, with MULTIFACE you can poke infinite lives, ammunition, etc. - and then **SAVE**.

**Q: MULTIFACE IS NOT THE ONLY 'MAGIC BOX' ON THE MARKET - WHY SHOULD I BUY IT MORE THAN ANYTHING ELSE?**

**A:** There are four devices on the market. Action Reply by Dated Electronics, Disc Wizard by Evesham Micros, Mirage Imager and MULTIFACE TWO. Each manufacturer would naturally argue his product is the best buy - fortunately (for you and us), MICRONET recently compared all four units and MULTIFACE TWO came out the best in literally all respects: the most successful one - 100%, the ONLY AUTOMATIC ONE, the FASTEST ONE both in **LOADING AND SAVING** time, the one taking the **LEAST ROOM** when saving - and you still get a couple of EXTRAS: a **RESET** button and an extensive and unique **MULTI-TOOLKIT**.

**Q: MULTIFACE IS IT THE RIGHT THING IN THE RIGHT TIME IF ONLY IT PAID FOR ITSELF...**

**A:** But it does! By the time you buy 8 programs on tape instead of disc, you will have saved £40 - the cost of the MULTIFACE. The money you save on further programs is all yours. **MULTIFACE - worth every penny, saves you pounds!**

### Romantic Robot Disc Operating System

Just one ROM will turn your CPC into a professional set-up: With RODOS you can attach additional disc drives - 40/80 track, single/double sided and store more than 800k per disc.

# RODOS



But RODOS is in fact much more than a fast and perfect DOS. RODOS also gives you **RANDOM ACCESS, PRINTER BUFFER, full ROM manager, SILICON DISC**, altogether 54 new bar commands, enormous power - all this and much more for **£29.88** only!

## multiface two

**SPRING MAIL ORDER SALE PRICE**  
**£ 42.88**

**RODOS**  
**INTRODUCTORY OFFER-ON ROM**  
**£ 29.88**

The special price of £42.88 applies strictly to mail orders received with coupon below before the 30 June 1988

Tape-to-disk at the touch of a button. Ridiculous, you may say, but it works every time. *Multiface* can stop any program in its tracks and save the program from memory to either tape or disk. It's completely fool-proof. Similar products have had problems with screen size, colour and even sound; *Multiface* can handle all these without a second thought.

That alone would have satisfied many people, but Romantic Robot has gone one step further, incorporating a memory editor. No program is safe with this: everything is out in the open, including the Z80 registers, CRTC data and any part of memory.

Don't be fooled into thinking this will result in mass piracy, however. The *Multiface* unit itself must be plugged into your Amstrad to allow reloading of a program it saved.

*Multiface II* must be the cleverest hardware device at present - a necessity for disk owners who thought they were stuck with loading from tape every time.

AMSTRAD ACTION JANUARY 1987

## THE YEAR OF THE ROBOT - BE PART OF IT

I order MULTIFACE 2 (£42.88)  / RODOS (£29.88)  plus p&p UK £1, Europe £2, Overseas £3

I enclose a cheque PO for £..... or debit my  No  Card exp.....

Name & address .....



# In search of simulation

By air, land and sea Gary Barrett goes in search of the ultimate realism in simulators of all kinds.

## What are simulators?

Have you ever dreamt of diving to the bottom of the ocean in a submarine, looking out over the Earth's surface from space or hunting down enemies from the pilot seat of a supersonic jet? Most of us have, and through simulators all of these dreams and many others can be realised. You can even come down to earth with simulations of motorbike riding and car racing, or really take-off with futuristic simulators that draw heavily from science fiction.

Simulators fall somewhere in between strategy games and arcade games. They have elements of gameplay that require thought, but you get a more graphical representation of your surroundings. The action sequences aren't exactly fast and furious like you get in a typical arcade shoot-em-up, they're just to give you a feeling of being there. There are exceptions to this though, *ATF* for example has excellent graphics that are an essential part of the game.

## Just how realistic are they?

Simulators tend to fall into two categories: those that go for total realism and the ones that ignore reality a little in favour of gameplay. *Nigel Mansell's Grand Prix* loses out on realism to some extent, but it is easy to just grab a joystick and get racing. *Silent Service* on the other hand is very close to the behavior of a real submarine, but it goes over the top a little on details, losing some of its appeal to all but the most dedicated players.

## Coming soon

One simulation to watch out for in the not too distant future is *Gunship* by Microprose. It's a simulator of the Apache AH-64 attack helicopter. A long and informative operations manual gives you some background to AH-64 and there's also a quick start section to get you up and flying. There are five areas of the world in which you can fight with the difficulty level varying in each. *Gunship* is in the final stages of programming now and it should be on the streets by the end of June.

Another simulation to look out for is *PHM Pegasus* by Electronic Arts. This time it's a heavily armed hydrofoil that gets simulated. You can undertake any of eight missions that involve the destruction of hostile enemy shipping. You have control of helicopters that are used to find your targets and then skim across the surface of the sea to your target and blow it out of the water. This too is near completion.



## Up, up and away

### Ace

Game Busters/Cascade, £2.99 cass, £4.99 disk

Reviewed issue 18

You are the pilot of an all-weather, all-terrain jet whose homeland is under attack. As the last pilot you must defeat the enemy forces and save your country. Mid-air refuelling, air-to-ground attack and air-to-air are all included in the game. There's also a map mode to help you find your foes. This originally came out as a full priced game, but now you can get it at a budget price so it's well worth a look.



### Ace of Aces

US Gold, £9.99 cass, £14.99 disk

Reviewed issue 21

World War Two is the setting for this simulation of the Mosquito fighter bomber. You have a choice of four missions to undertake, or you can go for them all together. Submarines, enemy bombers, trains and V1 rockets can be attacked with bombs and rockets. Enemy fighters are a threat to your safety, but they can be shot down with your machine guns.

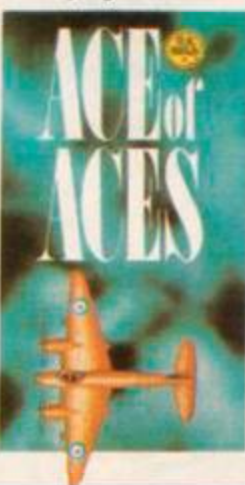

You play the part of navigator, pilot and bomb aimer. You also have to make sure that your aircraft doesn't burst into flames after receiving damage.

### Acrojet

Microprose, £9.95 cass, £14.95 disk

Reviewed issue 18

Aerobatic flying is a dangerous sport of stunts and manoeuvres at high speed and low altitude. This simulation offers ten different aerobatic events ranging from pylon races and slaloms to ribbon cuts and flame-out landings. You get a similar view of your aircraft to that in *ATF*, above and to the rear of the plane. Controlling the plane at low altitude is not the easiest thing in the world to accomplish, but with practice you'll soon be doing stunts with the best of them.

### ATF

Digital Integration, £8.95 cass, £13.95 disk

Reviewed issue 31

This is a hybrid simulator/strategy game with the emphasis being roughly equal. It's fairly unusual in that it doesn't give you a view through the cockpit, but from slightly above and to the rear of the aircraft. The strategy element comes across in the form of a tactical wargame against superior enemy numbers. The combination of the two game styles works well to provide an enjoyable and demanding game, with lots of skill levels to keep you battling it out.

### Combat Lynx

Elite Top Ten Collection, £9.99 cass, £14.99 disk

Reviewed issue 1

You have three Lynx attack helicopters with which to drive off the enemy invasion. Enemy ground and air forces are heading for your bases, your mission is to seek and destroy the enemy and pick up injured men from the battle zone. If you lose all of your bases then you'll have nowhere to re-arm, re-fuel or return with injured men. This is another game that's on the borderline between simulation and arcade game, but the emphasis is towards the simulator.



### Dambusters

Powerhouse, £1.99 cass only

On the 16th of May 1943 a squadron of converted Lancaster bombers departed

for Germany with the mission to destroy a series of dams in the Ruhr valley. You get to crew one of the bombers as pilot, navigator, engineer, gunners and bomb aimer. Getting to your target is not too difficult, but destroying a dam is trickier because of the low altitude of the attack. Flak, searchlights, barrage balloons and enemy fighters must all be avoided or destroyed. Although it's not a particularly realistic simulator it is fun to play and at a budget price it's well worth getting.



Flak, searchlights, barrage balloons and enemy fighters must all be avoided or destroyed. Although it's not a particularly realistic simulator it is fun to play and at a budget price it's well worth getting.

### F-15 Strike Eagle

Microprose, £9.95 cass, £14.95 disk

Reviewed issue 24

There are four skill levels to this simulator of the American F-15 Eagle. You also get to fly a variety of missions as you sweep across the landscape hunting down hostile enemy aircraft. You get the traditional cockpit view of your surroundings with a heads-up display of the more important information. You have a choice of weapons to use and several bases to land at for re-arming and refueling. The F-15 is highly manoeuvrable and you can do some elaborate moves to evade and destroy your foes. It's not fantastically fast, but it does have a fairly high element of realism.



### Fighter Pilot

Digital Integration, £8.95 cass, £13.95 disk

Reviewed issue 1

Another simulator where you get to fly the F-15 Eagle. There are no bombing missions in this one though, just straight air to air combat. As with many simulations you can spend a lot of time trying to find your target and once found they're not easy to shoot down. It's a pity that there aren't any more detailed missions because if you play it as a shoot-em-up you'll soon get bored with it.

### Spitfire 40

Mirrorsoft, £9.95 cass, £14.95 disk

Reviewed issue 5

World War Two is the setting for this simulation of the famous Battle of Britain fighter plane, the Spitfire. Fly around southern England hunting down the Luftwaffe, collecting medals as you go. There are two screen displays: a view through the cockpit and the control panel. A map of southern England can also be called up. If you want a simulation that's more of a shoot-em-up than a simulator then have a look at this because it's very easy to fly.



### Strike Force Harrier

Mirrorsoft, £9.95 cass, £14.95 disk

Reviewed issue 7

One of the more graphically pleasing simulators, this pits you against huge enemy land and air forces. Your eventual goal is to knock out the enemy HQ, but first you must leapfrog up the map, building airbases as you go. The manual devotes a section to aerial tactics, explaining each manoeuvre vividly.

Difficulty levels include the option of blacking out due to high acceleration, and more intelligent enemy pilots. The controls of the Harrier Jump Jet have been faithfully reproduced: piloting is just demanding enough to give the game realism. Very good.

### Tomahawk

Digital Integration, £9.95 cass, £14.95 disk

Reviewed issue 8

The Apache AH-64A attack helicopter is the star of this simulation. The Tomahawk is a tank buster and you're armed with an assortment of weapons to seek and destroy them. You get a 3D vector graphics view of the surrounding terrain with your enemies also viewed in vector graphics. There are only a few helicopter simulations and this is the best available.



## Dive, Dive, Dive

### Blue War

US Gold, £14.99 disk only

Reviewed issue 28

Seek and destroy is your mission as commander of a U79 submarine. As you sink more and more enemy vessels you are promoted through the ranks. You can look in the different sections of the submarine: the operations room, radar room, engine room and of course the periscope. Finding a target is time consuming and then actually managing to hit the ship with your torpedoes is not easy.

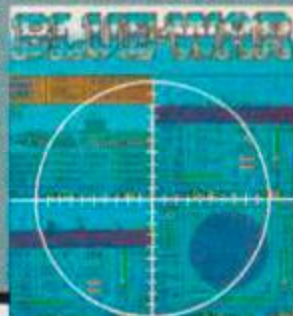

## Burnin' Rubber

### Nigel Mansell's Grand Prix

Martech, £9.99 cass, £14.99 disk

Reviewed issue 32

A series of 16 gruelling grand prix races lie ahead of you in the quest for the world championship. The duration of the races can be altered from a simple five lap race up to a full grand prix. Points are awarded according to your finishing position in the race and champion declared at the end of the season. It's not the most realistic simulation of all time, but it's the only car racing one worthy of mention.

### TT Racer

Digital Integration, £9.95 cass, £14.95 disk

Reviewed issue 19

## The Final Frontier

### Elite

Firebird, £12.95 cass, £14.95 disk

Reviewed issue 5

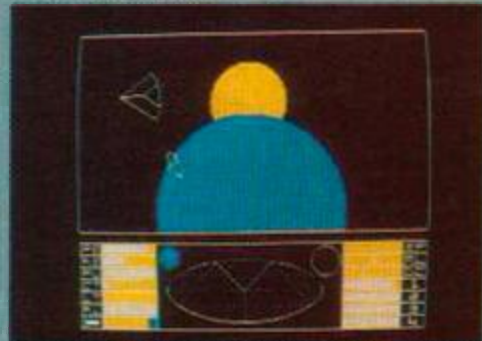

Although this is not strictly a simulation it is still the best attempt so far at guessing the future. There is a strategy element to it as well, but most of the game revolves around navigating your ship through space.

You also have to watch out for enemy vessels trying to sink you. A nice try, but it doesn't have enough action to keep you occupied for long.

### The Hunt for Red October

Grand Slam, £14.95 cass, £19.95 disk  
Reviewed issue 33

You are the captain of the new Soviet submarine Red October on it's maiden voyage. Defection is on your mind, but you haven't told your crew. The Soviet forces are out to sink you and the western forces are trying to save you. If it wasn't for the fact that it's too difficult to survive it would be a very good simulation. Another point against it is the price, £15 for the cassette version is enough to put many people off.



### Silent Service

Microprose, £9.95 cass, £14.95 disk

The western Pacific ocean is the setting for this excellent World War II simulator. You command an American submarine: your task is to sink enemy (Japanese) shipping. There are several preset scenarios that you can play through which are of varying difficulty. The manual supplied is, like all Microprose products, detailed and lengthy giving plenty of background information and hints to get you going. It's a very realistic simulation that will keep more advanced players occupied for many months.



Simulations of motorbike racing are thin on the ground and this one is still probably the best around, even though it's a couple of years old. It's a little unrealistic in detecting crashes, but other than that you can have plenty of fun racing around courses at high speed. There are a several options that make the game easier or harder to play.



### The source of simulation

Activision ☎01 431 1101  
23 Pond Street, Hampstead, London NW3 2PN  
Cascade ☎0423 525325  
1-3 Haywra Crescent, Harrogate, N. Yorkshire HG1 5BG  
Digital Integration ☎0276 684959  
Watchmoor Trade Centre, Watchmoor Road, Camberley, Surrey GU15 3AJ  
Electronic Arts ☎0753 49442  
Langley Business Centre, Station Road, Slough SL3 8YN  
Elite ☎0543 414188  
Anchor House, Anchor Road, Aldridge, Walsall, WS9 8PW  
Firebird ☎01 240 8838  
First Floor, 64-76 New Oxford Street, London WC1A 1PS  
Grand Slam ☎01 439 0666  
8-12 Paul Street, London EC2  
Microprose ☎0666 54326  
2 Market Place, Tetbury, Gloucs GL8 8DA  
Mirrorsoft ☎01 377 4645  
Athene House, 66-73 Shoe Lane, London EC4P 4AB  
US Gold ☎021 356 3388  
Units 2/3, Holford Way, Birmingham B6



and blasting lots of space ships. Ok so there's some shoot-em-up in their too. It's an excellent game that has plenty of long term appeal.

### Space Shuttle

Activision, £9.99 cass, £14.99 disk  
Reviewed issue 14

Flying a space shuttle may sound fun, but Activision's flight into space didn't turn out brilliantly. The idea is to fly into space and deploy or collect satellites. There are three

difficulty levels: one being a demo, the second gives you some control and the final one is a full scale mission. The major problem is that there is so little variation in things that you can do. Once you've done one flight, you've done them all and you can then only go for points.



## AMSTRAD INTERFACES & SOFTWARE

NEW "SCREEN MASTER" for the AMSTRAD CPC464/664/6128 & PCW

This program allows you to create letters and graphics any size on the screen, you can then add texture and background etc.

Text any SIZE... Graphic any SIZE... Even PICTURES  
Change position, with, height, and spacing  
Add texture/background to any part of the screen  
Move, Copy, Invert, Rotate, Flip, Reverse, Delete, any part  
Add boxes around text etc  
Edit screen using 8 x 8 zoom matrix  
Draw Free Hand with any Character or User Graphic  
Load screens from other programs  
Load, Save, Merge screens in normal or compressed form  
Load, Save, User defined graphics  
Boxes, Texture and Backgrounds can all be user defined  
Print screen copy ACROSS or DOWNWARDS in a variety of sizes

On disc at Only £29.95 inc V.A.T. & P&P

\*\*\*\* A 5 1/4" disc drive for the AMSTRAD CPC464/664/6128 \*\*\*\*

Double sided and Double density, 80 Track, Software available on Disc or /Rom  
Operate at full capacity under AMSDOS, CPM 2.2, and CPM PLUS  
Only £139.95 inc VAT, This inc DISCS S/W (Please add £4 for P&P)  
Rom software with Discs drive £19.95 inc VAT  
Disc software only £29.95 Rom software only £39.95

\*\*\*\*NEW 8 BIT PRINTER PORT Ver.2\*\*\*\*

Allows 8 bit printers to operate to their full potential on the 7 bit Amstrad. Sends ALL256 codes to your printer. Used in conjunction with AMSDOS, CPM PLUS.  
TAPE Plugs between computer and printer. No modifications are required. Can be used with DK Tronics interfaces (all models). This interface is a MUST FOR owners of Amstrad computers and 8 bit printers. ONLY £19.95 inc.

6 Way SIDEWAYS ROMBOARD

Accepts 276 series ROMs ie. 2764 and 27128 (8 or 16k ROMS)

ONLY £24.95 INC VAT

Printer "T" Switch

Connected 2 printers to your Amstrad CPC. Software controllable changeover

ONLY £24.95 inc VAT

OTHER ITEMS form K.D.S

PRICE inc VAT

CPC SERIAL INTERFACE 7 ROM S/W	£46.00
POWER CONTROLLER	£34.95
RS232 & CENTRONICS PORT (PCW)	£45.00
MINI-MAX MODEM (RS232 DRIVEN)	£80.50
COMMUNICATOR 104 MODEM (CPC)	£125.00
CHATTERBOX MODEM (PCW)	£130.00
PCW8256 5 1/4" 80T DS DISCS DRIVE	£129.95
PCW8512 5 1/4" 80T DS DISC DRIVE SWITCHED	£149.95
(please add £4 postage on Disc Drives)	
MINI-MAX PACK (MODEM + CPC SERIAL IF + CABLE)	£99.00

K.D.S Electronics

Dept AA, 15 HILL STREET, HUNSTANTON,  
NORFOLK. PE 36 5BS  
TEL: (04853) 2076



## LUDS SOFTWARE

Tital	Cass	Disc	Tital	Cass	Disc
Combat School	£9.00	£14.00	3D Grand Prix	£9.00	£13.00
Paperboy	£9.00	£14.00	Aces of Aces	£9.00	£13.00
Gauntlet 2	£9.00	----	5 Star Games 3	£9.00	£13.00
Silent Service	£9.00	£14.00	Driller	£12.00	£15.00
F15 Strike Eagle	£9.00	£14.00	Spitfire 40	£9.00	£13.00
Star Wars	£9.00	£13.00	Yes Prime Min/er	£12.00	£15.00
720 Degrees	£9.00	£13.00	Trivial Pursuits	£11.00	£15.00
Indianna Jones	£9.00	£13.00	Gryzor	£8.00	£13.00
ATF	£8.00	£12.00	3D Stunt Rider	-----	£13.00
Match Day 2	£8.50	£13.00	Acrojet	£9.00	£13.00
Magnificent 7	£9.00	-----	Impossible Mis/n	£9.00	£13.00
Solid Gold	£9.00	£15.00	Monopoly	£9.00	£13.00
Game Set & Match	£10.50	£15.00	Stike F/ Harrier	-----	£13.00
Live Ammo	£9.00	£13.00	Elite Collection	£12.00	-----



All prices include Post & Packing  
Cheques & Postal Orders Payable to  
LUDS SOFTWARE



Orders over £20 receive a FREE tape game or £2 off your next order  
LUDS SOFTWARE, LEA HOUSE, LEYTON INDUSTRIAL VILLAGE,  
ARGALL AVENUE, LEYTON, LONDON E18 7QP.

# WACCI

THE WORLDWIDE AMSTRAD CPC USERS CLUB

## THE SPECIAL OFFERS

	Rom	Disc	Cass		
Protext	31.00	21.00	15.00	Rombo Rom Box	27.00
Prospell	27.25	19.50	-	Vidi-CPC Digitiser	68.00
Promerge Plus	27.25	-	-	464/664 Speech Synth Rom	39.95
Promerge	-	19.50	-	6128 Speech Synth Rom	35.95
Maxam	31.00	21.00	15.00	10 x Amsoft CF2 Discs	23.95
Utopia	23.25	-	-	Protext Office Disk	27.25
Model Universe	-	15.00	12.00	Maxam 1 1/2 Rom	23.25
CP/M+ Protext	-	47.00	-	BCPL Rom	23.25
CP/M+ Maxam II	-	39.00	-	Micro Music Creator Rom	19.95
CP/M+ Armor C	-	39.00	-	Rombo Rom Box	27.00
				Vidi CPC Digitiser	68.00
				TV Receiver/Tuner	65.95

## THE PUBLIC DOMAIN SOFTWARE

<b>CPM DISC 1 - MACHINE CODE TOOLS</b>	Price £6.50
Z80 and 8080 assemblers, Z80 to 8080 to Z80 code translator, Debugging monitor and assembler, Reverse assembler, Binary File comparer, plus NewSweep and more.	
<b>CPM DISC 2 - COMPUTER LANGUAGES</b>	Price £6.50
Small-C, Prolog, Lisp, EBasic, Small-C-Interpreter plus NewSweep	
<b>CPM DISC 3 - FILE AND DISC MANAGEMENT</b>	Price £6.50
Library utilities, Disc quality checker, Unix GREP command, PCW disc reader, Disc sector editor, Text file sorter, Word counter, plus NewSweep and more.	
<b>CPM DISC 4 - AT YOUR LEISURE</b>	Price £6.50
Cave Adventure, Chess, Othello, Golf, Word search, Biorhythms, Maze generator, On-screen calculator, Prolog, Comms utility, plus NewSweep and more.	
<b>CPM DISC 5 - THE BUSINESS</b>	Price £6.50
Scrivener spreadsheet, Inventory database, Powerful text editor, Spelling checker with dictionary, Sorter, Word counter, Comms utility, plus NewSweep and more.	
<b>CPM DISC 6 and 7 - PASCAL PLUS (Two Discs)</b>	Price £10.00
Pascal, SCI, Cobol, EBasic, Powerful text editor, plus NewSweep.	

\* ALL PROGRAMS COMPLETE WITH ORIGINAL DOCUMENTATION AND SUPPORT FILES\*  
SAVE MONEY \* CPM DISCS 1 TO 5 FOR £29.95 - ALL 7 DISCS FOR £39.95 \* SAVE MONEY

WACCI UK, 59 THE GREEN, TWICKENHAM, MIDDX TW2 5BU  
EST. 1986 — PHONE 01-898 1090

## METAL ARMY

Players, £1.99 cass, joystick or keys

General Ironside and his Metal Army have invaded Slough nuclear power station and threatened to blow it up. In a situation like this you need a man with guts, a hero, someone stupid enough to go in and deactivate the bomb.

In the upper part of the screen is the playing area in which you run around blasting

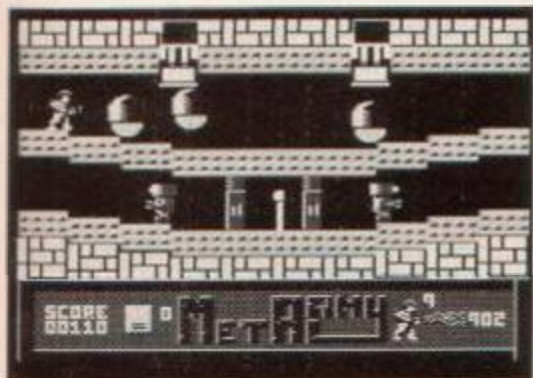

● Watch out for the bouncers

robots. Below that is your score, number of passes, lives and weapon energy. The passes are needed to access certain parts of the plant and you have nine lives initially.

The Metal Army are automated combat units that kill on contact, but fortunately you have a weapon that can immobilise and eventually destroy them. Unfortunately the gun

needs periodical recharging from power points throughout the nuclear plant. When the Metal Army arrived they caused some damage to the plant and as a result there are occasional discharges of coolant gas and fuel rods. Contact with either loses you a life.

Don't hold your breath waiting to hear a tune because you'll asphyxiate, there aren't any. Sound effects are very good though. The graphics are colourful and well animated.

The major problem with this is difficulty – even getting off the first screen is a major problem. Timing is what this is all about and some hazards require split second judgement or another life will be lost. Timing games are fine when you're in the mood, but the difficulty factor in this may well drive you crazy. One other

### SECOND OPINION

*Every once in a while you actually want to play a game that makes you scream in frustration. It lets you take out all your anger on the game rather than anything else.*

*This one fits the bill nicely. It's a very cathartic experience that may save you a few trick cyclist bills. Then again you may have to pay for repairs to the computer and your fists.*

BW

### GREEN SCREEN VIEW

*There are no problems seeing everything.*

stupid thing is that if you recharge your gun beyond the 999 maximum it goes back to zero.

GBH

### FIRST DAY TARGET SCORE

1000 points.

### The Verdict

**GRAPHICS** ..... 78%

- Colourful and well animated sprites.
- Nice explosions.

**SONICS** ..... 35%

- The few sound effects are good.

**GRAB FACTOR** ..... 46%

- Working out the timing is possible after a lot of games.
- Much too difficult to begin with.

**STAYING POWER** ..... 51%

- Large playing area full of robots.
- A simple mistake can make the game impossible to complete.

**AA RATING** ..... 53%

- There are many worse games at full price.

## ON CUE

Mastertronic, £2.99 cass, joystick or keys

Throw away your cue and pick up a joystick to battle it out on the green baize of your monitor. Just in case you've never played snooker before I'd better explain the rules. Snooker is played on a table with six pockets, one at each corner and one halfway down each of the long sides. There are 15 red balls in a triangular shape on the table and six colours that range in points value from two to seven. Reds are worth one point each. There's also a white ball that you strike with the cue and this is supposed to hit one of the other balls.

The idea is to pot a red ball followed by a colour until all of the reds have gone off the table. As long as you pot the right coloured

ball then your go continues. If you pot a colour and there are still reds left on the table it is replaced, it's also replaced if you pot it out of sequence when there are no reds left. The colours have to be potted in the sequence: yellow, green, brown, blue, pink and black.

On-screen you get an overhead view of the table with the balls all over the place. At the top of the screen is power meter, spin indicator and information window. A cursor is moved around the screen which is used to determine the balls path. Spin and power are then adjusted to see what happens after you hit the ball and then the shot is taken. That's about it for the mechanics of the game.

The graphics are colourful and you can tell which ball is which. Sound is limited to

the collision of balls and a beep when a foul is committed.

GBH

### FIRST DAY TARGET SCORE

Beat the computer on average difficulty.

### The Verdict

**GRAPHICS** ..... 43%

- Easy to identify all the balls in colour.
- Animation is a little flickery at times.

**SONICS** ..... 09%

- Beep and ping is all you get.

**GRAB FACTOR** ..... 46%

- Novice level gives you opportunity to practice for later levels.
- Snooker on computer is not one of the most exciting games ever.

**STAYING POWER** ..... 47%

- Three levels of computer opponent.
- You can also play against somebody else, or even solo.

**AA RATING** ..... 51%

- If haven't already got a snooker game then at a budget price it's good value.

### SECOND OPINION

*Computer snooker has never struck me as being very exciting, but at least in this case you get a computer opponent. I still think it can only be recommended to snooker fans, but then there are a lot of them about.*

BW

### GREEN SCREEN VIEW

*For those of you playing in green, the blue is the dark green one behind the slightly lighter green one and next to the very light green one.*



● You cannot be serious, that ball was in

# CHEAT MODE

Gary Barrett checks out your tips, pokes and game-busting ploys. The best ones win an entire issue's *Raves* and the *Mastergame*. Send your latest gem to: Cheat Mode, *Amstrad Action*, 4 Queen Street, Bath BA1 1EJ

## Cybernoid

Issue 32's *Mastergame* gets hacked to pieces by Justin Cole of Colchester. Not only can you have infinite lives, weapons, shields and invulnerability, but the game can also be speeded up. If you want it really weird then you can play upside down. If you don't want a particular feature then just delete the appropriate lines. The tape poke is entered using Method 1.



```

1 ' Cybernoid - tape
2 ' by Justin Cole
3 ' Amstrad Action July 88
10 MODE 1:INK 0,0:INK 1,24
20 INK 2,20:INK 3,26
30 BORDER 0
40 MEMORY &3FFF
50 LOAD"!loader",&4000
60 POKE &4152,201
70 add=&BF00
80 READ a$
90 IF a$="*" THEN CALL &BF00
100 READ tot$
110 tot=VAL("&"+tot$):t=0
120 FOR f=1 TO LEN(a$) STEP 2

```

```

130 v=VAL("&"+MID$(a$,f,2))
140 POKE add,v
150 add=add+1
160 t=t+v
170 NEXT
180 IF tot<t THEN PRINT "error":END
190 GOTO 80
200 'delete any unwanted line
210 'leave
220 DATA cd0040,10d
230 ' inf weapons
240 DATA 210d1a3600,7e
250 ' inf lives
260 DATA 21ae2b3600,130

```

```

270 ' invulnerability
280 DATA 213a2b36c9,185
290 ' inf shields
300 DATA 21810836002100,101
310 DATA 0022e80f22e90f,233
320 ' fast game
330 DATA 2141023600,9a
340 ' upside down
350 DATA 2140bf227303,1b8
360 DATA 21e90536c323,22b
370 DATA 36f7233605,18b
380 ' leave
390 DATA c30002,c5
400 DATA *
410 END

```

The disk version of Justin's poke does exactly the same. Just type in the poke, put the game disk in the drive and type RUN.

```

1 ' Cybernoid - disk
2 ' by Justin Cole
3 ' Amstrad Action July 88
10 MODE 1
20 add=&60
30 READ d$
40 IF d$="*" THEN CALL &60
50 READ tot$
60 tot=VAL("&"+tot$):t=0
70 FOR f=1 TO LEN(d$) STEP 2
80 v=VAL("&"+MID$(d$,f,2))
90 POKE add,v
100 add=add+1
110 t=t+v
120 NEXT
130 IF tot<t THEN PRINT "error":END
140 GOTO 30
150 ' leave
160 DATA 218200cdd4bc2283
170 data 3a5
180 DATA 0079328500210001
190 data 152
200 DATA 1e0016000e41df83
210 data 1e5
220 DATA 00218600228402c3
230 data 212
240 DATA 000184000000,85
250 ' inf weapons
260 DATA 21ad1b3600,11f
270 ' inf lives
280 DATA 214e2d3600,d2
290 ' invulnerability
300 DATA 21da2c36c9,226
310 ' inf shield
320 DATA 21210a36002100,a3
330 DATA 00228811228911,177
340 ' fast game
350 DATA 21e1033600,13b
360 ' upside down
370 DATA 2140bf22130521,17b
380 DATA 890736c32336f7,2d9
390 DATA 233605,5e
400 ' leave
410 DATA c38403,14a
420 DATA *
430 END

```

### POKE METHODS FOR TAPE

Here is how to input the majority of Cheat Mode tape pokes. The instructions for each poke tell you which of the two different methods to use. If you have a 664 or 6128, first type | tape.

#### METHOD 1

Rewind the game tape to the beginning. Now type in the poke listing. Then type RUN and press the Enter key. (Don't use the key marked CTRL or Control; that would stop the poke from working.) Press the Play key on the cassette deck, then any key on the main keyboard - spacebar will do nicely. The tape should now start to play through in the normal way.

#### METHOD 2

For this method you have to skip the first bit of the game program. To do that, start by rewinding the game tape to the beginning. Now type in the listing. Then type CAT and press Enter. Start the tape by pressing Play and then any key. Then watch the screen.

Soon you'll get the message Found *something* Block 1. It doesn't matter what the *something* actually is; this will vary from one game to another. If the Cheat Mode instructions just tell you to skip the first block, you should stop the tape here.

If the instructions tell you to skip several things, stop the tape when the Found message comes up for the last thing you're trying to skip.

Once you've stopped the tape, press Escape, type RUN and press Enter. Now press Play on the tapedeck and any key on the keyboard to start the tape running

If you just want infinite lives then use the define keys option to use keys Y,X,E and S. Redefine them again to something more sensible and you'll have infinite lives.

# Imagine

If you've been having trouble getting past some levels in Imagine's *Rave* game then press the keys T,A,I and O when the game is on the title screen. When you're playing the game just press ESC and the exits will appear. Thanks to **M. Mewett** and **R. Watts** of Hurst Green for this tip.



## Super Stunt Man

Codemasters' game of stunts gets infinite time and takes, courtesy of **Damon Querry** of Sunderland. Simply Enter "LIVEWIRE" into the high score table and the game becomes much easier.

## Reflex

**Martin Burke** of Coventry has sent in this tip for Player's game of bouncing balls. Instead of typing in your name on the high score table type in "CHEAT". When you next start you'll begin from where you left off.

## Four Smash Hits

Three of the four games on Hewson's compilation get hacked by **Steven Brand** of Glasgow. *Zynaps* and *Uridium* get infinite lives and *Exolon* gets infinite lives, ammo and grenades. Unfortunately *Ranarama* is the one that doesn't get hacked. The poke works out which game it is and pokes the relevant memory locations. It's entered using Method 1.

```

1 ' Four Smash Hits - tape
2 ' by Steven Brand
3 ' Amstrad Action July 88
10 MODE 1:MEMORY 12345
20 LOAD "loader",44000
30 a=16709:BORDER 0
40 IF PEEK(a)=4DD THEN
  RESTORE 240
50 IF PEEK(a)=480 THEN
  RESTORE 260
60 READ m:MODE m
70 x=(15 AND m=0) OR (3 AND
m=1)
80 FOR c=0 TO x
90 READ f:INK c,f
100 NEXT
110 tot=0
120 RESTORE 280
130 FOR a=480 TO 4C3
140 READ b:b=VAL("4"+b$)
150 POKE a,b:tot=tot+b
160 NEXT
170 IF tot<5914 THEN PRINT
"error"
180 CALL 480
190 DATA 0
  
```

```

200 DATA 00,26,13,16
210 DATA 15,06,03,24
220 DATA 12,09,18,19
230 DATA 20,11,02,01
240 DATA 01
250 DATA 00,06,18,26
  
```

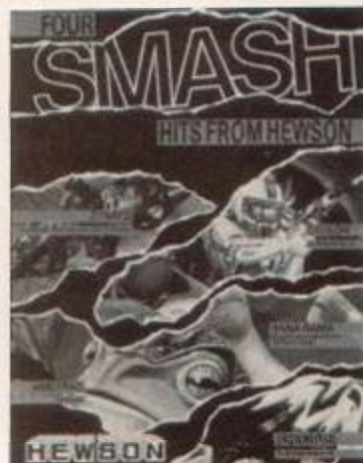

```

260 DATA 01
270 DATA 00,20,26,24
280 DATA 21,00,40,e5
290 DATA 3a,45,41,fe
300 DATA dd,28,13,fe
310 DATA 80,28,26,21
320 DATA 96,00,22,4e
330 DATA 41,c9,3e,c9
340 DATA 32,4e,60,c3
350 DATA 00,90,21,a5
360 DATA 00,22,53,41
370 DATA c9,af,32,59
380 DATA 11,32,7a,1f
390 DATA 32,25,2a,32
400 DATA 25,2b,c3,00
410 DATA 01,21,bc,00
420 DATA 22,4e,41,c9
430 DATA af,32,c2,5e
440 DATA c3,00,40,4a
450 END
  
```

## Get Dexter II

**Peter Featherstone** of Leeds has hacked into Infogrames *Rave* game. It gives you 99% thrust and infinite energy in the first part of the game. You can then go straight onto the second half of the game. Put the game disk in the drive and run the poke.

```

1 'Get Dexter II - disk
2 'by Peter Featherstone
3 'Amstrad Action July 88
10 |A
20 MODE 0
30 OPENOUT "d":MEMORY 43E7
40 LOAD "pandora.kev",43E8
50 FOR f=4BE0 TO 4BFF
60 READ a$:IF a$="*" THEN
90
70 POKE f,VAL("4"+a$)
80 NEXT f
90 CALL 4BE0
100 DATA 21,99,b0,11,e8,03
110 DATA 01,0d,00,ed,b0,21
120 DATA a6,b0,11,00,03,01
130 DATA 14,00,ed,b0,c3,e8
140 DATA 03,af,cd,3b,06,32
150 DATA 4d,05,cd,ab,04,cd
160 DATA 00,03
170 'Inf Energy
180 DATA af,32,ca,14
190 DATA 3e,c9,32,b9,14
200 '99% Trust
210 DATA 3e,99,32,14,4f
220 DATA c9,70,68,65,77,21
230 DATA *
240 END
  
```

## Get Dexter

The freebie on the B side of *Get Dexter II* also gets hacked by **Peter**, it gives you infinite energy. Put the game disk in the drive and run the poke.

```

1 'Get Dexter 1 - disk
2 ' by Peter Featherstone
3 ' Amstrad Action July 88
10 MODE 1
20 FOR f=4BE0 TO 4BEF
30 READ a$:POKE 40
f,VAL("4"+a$)
50 NEXT f
60 CALL 4BE0
70 DATA 21,ab,b0,c1,d4,bc
80 DATA 22,a8,b0,79,32,aa
90 DATA b0,21,00,01,11,00
100 DATA 00,0e,41,df,a8,b0
110 DATA 21,a1,b0,22,45,02
120 DATA c3,00,01,af,32,72
130 DATA 73,c3,00,a7,00,00
140 DATA 00,84,00,00,00,00
  
```



## Jack the Nipper

**Matthew Spires** of Amberley has sent in some tips for the second Gremlin game of naughtiness.

- 1) Your target is the temple of naughtiness. When you get there you will find that it is sealed off by a stone wall and you can only enter if you have accumulated enough points on the naughty-ometer.
- 2) Spreading the grease on tarzan's vine makes him slip off and gains you naughtyometer points.
- 3) Throwing coconuts at the beehive makes them rush out, don't stand in the doorway though or you'll lose a life.
- 4) The mouse scares the elephant that is resting against a tree, near the natives hut.



- 5) The onion should be taken to the hyenas and dropped on the floor to make them burst into tears.
- 6) Coconuts should be thrown at any target. This will not affect the naughtyometer but it will score you more points.
- 7) The shield protects you from any danger, but it wears off after 20 seconds so be careful.
- 8) Go sparingly with the coconuts if you are aiming for ultimate naughtiness, as you may use essential ones and run into difficulties.
- 9) When swinging over water on the vines, try not to go too far down the rope as you will hit the gorillas and lose a life.
- 10) The dummies give you more lives so try and find them.



## Whoops!

Issue 32's *Manic Miner* poke for the Software Projects version was incorrect as printed. Line 20 should have been:

```
20 LOAD"!DATA MK1 V1.3"
```

Make sure that there is a space between !DATA and MK1 a space between MK1 and V1.3.

## Bravestarr

```
1 ' Bravestarr - tape
2 ' by Phil Howard
3 ' Amstrad Action July 88
710 IF y=5152 THEN 810
720 PRINT"ERROR IN KEY":END
730 '
740 DATA 1D,BC,41,B4,11,14,2A,52
750 DATA B2,4E,59,C6,65,59,E1,A1
760 DATA 15,45,58,DC,24,18,11,A7
770 DATA 55,A8,79,54,41,56,27,12
780 DATA C1,57,46,14,65,14,11,32
790 DATA 1B,53,E1,41,BA,45,36,B1
800 DATA 52,DA,E6,80,00
810 '
820 '**** CHEAT ****
830 '
840 y=0:RESTORE 910
850 FOR x=&BE80 TO &BE9A
860 READ a$:a=VAL("&"+a$)
870 POKE x,a:y=y+a:NEXT
880 IF y=3068 THEN 960
890 PRINT"ERROR IN CHEAT":END
900 '
910 DATA 21,4d,98,CD,44,43,C3,D5
920 DATA 42,21,92,BE,22,41,A2,C3
930 DATA B4,A0,CD,03,B9,3E,00,32
940 DATA 49,30,C9
950 '
960 MEMORY &1FFF
970 LOAD"BRAVESTARR"
980 MODE 1:PRINT"Don't Panic..this takes
FOREVER..
990 CALL &BE80
1000 END
```

## Rygar

```
1 ' Rygar - tape
2 ' by Phil Howard
3 ' Amstrad Action July 88
710 IF y=4810 THEN 810
720 PRINT"ERROR IN KEY":END
730 '
740 DATA 17,4C,16,79,B5,4A,26,21
750 DATA 1B,3D,12,39,7E,BD,15,84
760 DATA 31,5E,11,12,18,DE,95,44
770 DATA D2,11,BA,11,51,64,52,16
780 DATA 25,BC,1A,C4,64,C4,58,E1
790 DATA 5A,B5,A5,54,A6,41,11,54
800 DATA 54,85,32,50,00
810 '
820 '**** CHEAT ****
830 '
840 y=0:RESTORE 910
850 FOR x=&BE80 TO &BE9A
860 READ a$:a=VAL("&"+a$)
```

## Go Loaders - Part 2

Due to lack of space last month some of Phil Howard's pokes had to be held over until now.

If you have the Lock-key routine from last month then you'll only have to type in the pokes this month and you can ignore the Lock-key program. If you didn't, then first of all type in the program below and save it on tape or disk as SAVE"LOCK".

Next type in the poke that you want to use and save it to tape or disk as SAVE filename\$,A where filename\$ is a suitable name for the poke.

Then do the the following:

```
LOAD"LOCK"
MERGE filename$
RUN
```

The poke will then run, but it will take quite a time to do it, about 3.5 minutes.

```
1 ' Lock-key
2 ' by Phil Howard
3 ' Amstrad Action July 88
10 '**** LOCK ****
20 '
30 Y=0:RESTORE 100
40 FOR x=&4200 TO &4386
50 READ a$:a=VAL("&"+a$)
60 y=y+a:POKE x,a:NEXT
70 IF y=37465 THEN 590
80 PRINT"ERROR IN LOCK":END
90 '
100 DATA FE,00,20,03,C3,3B,43,FE
110 DATA 01,20,07,DD,36,0F,F6,0E
120 DATA 10,C9,FE,02,20,07,DD,36
130 DATA 0C,F9,0E,0D,C9,FE,03,20
140 DATA 0F,DD,36,1E,E9,DD,7E,0C
150 DATA D6,10,DD,77,0C,0E,1F,C9
160 DATA FE,04,20,07,DD,36,11,F6
170 DATA 0E,12,C9,FE,05,20,07,DD
180 DATA 36,10,F6,0E,11,C9,FE,06
190 DATA 20,07,DD,36,0D,F8,0E,0E
200 DATA C9,FE,07,20,07,DD,36,1B
210 DATA EE,0E,1C,C9,FE,08,20,07
220 DATA DD,36,0E,F7,0E,0F,C9,FE
230 DATA 09,20,07,DD,36,23,C0,0E
```

```
240 DATA 24,C9,FE,0A,20,13,DD,E5
250 DATA E1,11,06,00,19,7C,D6,10
260 DATA DD,75,15,DD,77,16,0E,17
270 DATA C9,FE,0B,20,13,DD,E5,E1
280 DATA 11,06,00,19,7C,D6,10,DD
290 DATA 75,14,DD,77,15,0E,16,C9
300 DATA FE,0C,20,13,DD,E5,E1,11
310 DATA 07,00,19,7C,D6,10,DD,75
320 DATA 10,DD,77,11,0E,12,C9,FE
330 DATA 0D,20,0F,DD,7E,03,D6,10
340 DATA DD,77,03,DD,36,1A,E9,0E
350 DATA 1B,C9,DD,36,1D,20,DD,36
360 DATA 1E,EB,0E,1F,C9,F3,21,39
370 DATA 7D,11,39,5D,00,01,00,0D
380 DATA ED,B0,21,36,6D,11,37,6D
390 DATA 01,00,10,36,00,ED,B0,36
400 DATA C3,23,36,34,23,36,43,21
410 DATA D5,42,11,39,6D,01,0D,00
420 DATA ED,B0,21,40,6D,36,EB,21
430 DATA 50,7D,11,50,6D,01,15,00
440 DATA ED,B0,21,FF,40,DD,21,58
450 DATA 7D,23,E5,7E,CD,00,42,DD
460 DATA E5,E1,5D,7C,D6,10,57,06
470 DATA 00,DD,09,ED,B0,ED,73,00
480 DATA 40,C3,39,6D,ED,7B,00,40
490 DATA E1,18,DE,E1,ED,4B,02,40
500 DATA D9,C3,89,BE,22,D7,42,7C
510 DATA D6,10,67,22,FB,42,22,32
520 DATA 43,E5,7C,D6,10,67,22,DA
530 DATA 42,E1,2B,2B,2B,22,E3,42
540 DATA 23,22,E6,42,11,09,00,19
550 DATA 22,03,43,11,10,00,19,22
560 DATA 0B,43,11,00,10,19,22,00
570 DATA 43,11,08,00,19,22,17,43
580 DATA F3,D9,ED,43,02,40,C9
590 '
600 '**** KEY ****
610 '
620 y=0:x=&4100:RESTORE 740
630 WHILE a$<>"00"
640 READ a$:y=y+VAL("&"+a$)
650 POKE x,VAL("&"+LEFT$(a$,1))
660 POKE x+1,VAL("&"+RIGHT$(a$,1))
670 x=x+2:WEND
680 '
690 '-----
700 '

```

```
870 POKE x,a:y=y+a:NEXT
880 IF y=3135 THEN 960
890 PRINT"ERROR IN CHEAT":END
900 '
910 DATA 21,55,94,CD,44,43,C3,D5
920 DATA 42,21,92,be,22,73,9e,c3
930 DATA d0,9c,cd,77,9e,21,1f,13
940 DATA 36,00,c9
950 '
960 MEMORY &1FFF
970 LOAD"RYGAR"
980 MODE 1:PRINT"Don't Panic..this takes
FOREVER..
990 CALL &BE80
1000 END
```



## How to win an ENTIRE ISSUE'S rave software!

If you want to win an entire issue's Rave software, including the *Mastergame*, then all you have to do is produce an excellent map, poke or playing tips.

The best solution will win a copy of every Rave and the *Mastergame* from the issue in which the solution is printed. We also give five runner-up prizes every month of a Rave or the *Mastergame* in that issue. Justin Cole wins the *Mastergame* and all the Raves this month for his excellent *Cyberoid* pokes. The runners up that will receive either the *Mastergame* or a Rave are: Steven Brand, Peter Featherstone, and Matthew Spires



# CLASSIC COLLECTION

The section where we reprint requested favourite pokes from the past. If you missed out on a poke for a

## Thing on a Spring

If you're having trouble because of running out of oil then press the keys T, H, I, N and G on the title screen to get infinite oil.

## Finders Keepers

Richard Hodges has poked into Mastertronic's budget title to give you infinite lives. It's entered using method two, skip past the block call FK BLOCK 1 % and start loading from the block called FK BLOCK 1 &.

```
1 ' Finders Keepers - tape
2 ' by Richard Hodges
3 ' Amstrad Action July 88
10 OPENOUT"DUM"
20 MEMORY &7FF
30 LOAD"!FK", &800
40 POKE &20CE,0
50 CALL &800
60 END
```

## Bounty Bob Strikes Back

SA Hulley of Hemel Hempstead has come up with a poke for infinite lives in US Gold's game. It's entered using Method 1.

```
1 ' Bounty Bob - tape
2 ' by SA Hulley
3 ' Amstrad Action July 88
10 MEMORY &3900:CLS
20 LOAD"":LOAD"!"; &4040
30 a=&8900
40 FOR n=0 TO 51
50 READ d$
60 POKE a+n,VAL("&"+d$)
70 NEXT
80 CLS:PRINT "PLEASE WAIT"
90 CALL &8916
100 DATA 21,6e,06,36,18,2c
110 DATA 36,05,c3,40,00,21
120 DATA 34,bd,36,00,2c,36
130 DATA 89,c3,04,bd,f3,11
```

```
140 DATA 40,00,21,00,bb,01
150 DATA 37,02,d5,e5,c5,78
160 DATA 21,4b,40,36,72,2e
170 DATA 4e,36,92,6c,ed,b0
180 DATA 37,c3,2c,b8
190 END
```

## Electro Freddy

If you want 255 lives in Amsoft's factory game then enter this poke using Method 1.

```
1 ' Electro Freddy - tape
2 ' Amstrad Action July 88
10 MEMORY 10000
20 LOAD"A1"
30 FOR n=1 TO 4
40 LOAD""
50 NEXT
60 POKE 39356,255
70 CALL 39323
80 END
```

## Swords and Sorcery

Rhys Jones of Peterborough sent in this poke for the PSS's game of dungeon bashing. It's used to create a super character.

```
1 ' Swords and Sorcery
2 ' by Rhys Jones
3 ' Amstrad Action July 88
10 MODE 2
20 MEMORY HIMEM-13
30 FOR t=HIMEM+1 TO HIMEM+12
40 READ a
50 POKE t,a
60 NEXT
70 PRINT"Insert tape to load saved game then press any key"
80 WHILE INKEY$="" :WEND
90 CALL HIMEM+1
100 PRINT:PRINT"Current name is"
110 FOR t=39820 TO 39835
120 PRINT CHR$(PEEK(t)) AND &7F;
130 IF PEEK(t)>&80 THEN t=39835
140 NEXT
150 PRINT
160 PRINT
170 INPUT "New name":a$
180 IF LEN(a$)>16 OR LEN(a$)<1 THEN 170
190 a$=UPPER$(a$)
200 a$=LEFT$(a$, LEN(a$)-1)+CHR$(&80+ASC(RIGHT$(a$),1))
210 FOR t=1 TO LEN(a$)
220 POKE 39819+t, ASC(MID$(a$,t,1))
230 NEXT
240 PRINT
250 POKE 39785,200
260 POKE 39786,200
270 POKE 39797,200
```

```
280 POKE 39800,200
290 POKE 39784,200
300 POKE 39791,200
310 POKE 39798,200
320 POKE 39367,200
330 POKE 39814,200
340 POKE 39796,200
350 PRINT "New values poked"
360 PRINT
370 POKE HIMEM+10,158
380 PRINT"Insert tape to save new character on and press any key"
390 WHILE INKEY$="" :WEND
400 CALL HIMEM+1
410 DATA 33,171,138,17
420 DATA 108,18,62,22
430 DATA 205,161,188,201
440 END
```

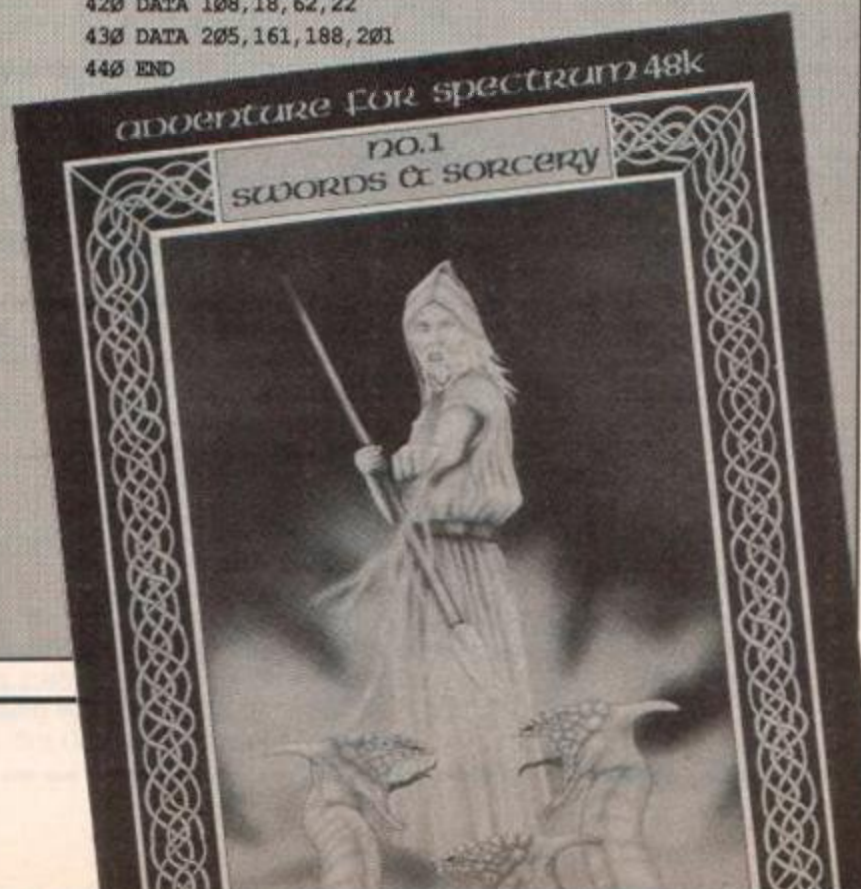



# PILGRIM<sup>THE</sup>

Time and Magik from Level 9/Mandarin is in the pipeline, Magnetic Scrolls are hard at work on Corruption, Bard's Tale is STILL not finished, and the Pilgrim's back from India...

## Time and Magik

### Level 9/Mandarin

We've seen all these games before, haven't we, fellow Pilgs? So why should we fork out another £14.95 to get them in Trilogy form?

To answer the first question first, HAVE you seen these games before? Let's just remind ourselves what they're all about and why, for any fan of Level 9, these three titles happen to be among the most significant of their later releases.

Level 9 built its reputation on fantasy with the Middle Earth trilogy (now available from Rainbird as *Jewels of Darkness* and one of the best classic adventure collections around). Everybody was busy finding treasure in underground caverns when suddenly the Austins stunned the adventure world with *Snowball*.

Not only was *Snowball* science fiction, but it boasted a whole host of innovations – not least the

size of the game, which claimed thousands of (admittedly rather similar) locations. The game was also, in parts, extremely difficult with tough puzzles backed up by a complex map that could easily confuse the novice player – and some more experienced ones to boot.

The up shot of all this was that Level 9, perhaps propelled slightly by public (or rather press) opinion, launched into their "sci-fi" phase and released two further games – *Return to Eden* and *The Worm in Paradise*. As you probably know,

this entire trilogy is also available from Rainbird (*Silicon Dreams*).

### Red Moon

It's at this stage that *Red Moon* appeared. It was hailed at the time as one of the best Level 9 games to appear for ages, but in retrospect this was almost partly because of the return to magik and fantasy – a development viewed with relief by die-hard fantasists.

There was another reason, however. *Red Moon* was one of the earlier Level 9 games with graphics and although they were somewhat crude, they combined with some of the most atmospheric locations that the

## Cream On Top

The big idea with all these compilations of Level 9 games is that the originals have been "reprogrammed" – what do you get?

First and foremost, you get digitised graphics. That doesn't mean you get very realistic images as in the *Magnetic Scrolls* titles, but it does mean that the pictures are a vast improvement on the earlier Level 9 pictures, which were – to say the least – uninspiring in both colour, style, and content. And of course *Lords of Time* had no pictures at all in the original version.

Next, you get rather more stylish programming. The biggest difference here, in real terms, is the RAMsave facility but you can also enjoy a slightly more powerful parser. The improved parser is something of an unnecessary bonus since the basic structure of the games remains unaltered and therefore you don't really NEED a more powerful command structure – but it is a much more friendly system than before.

Finally, you get the scrolling graphics as in the *Magnetic Scrolls* games and a picture cache that cuts down on disk accesses. Not bad for under 15 quid.

company had come up with for ages. Although the game lacked the subtlety of the science-fiction series, it made up for it by simply oozing with mystery and imagination.

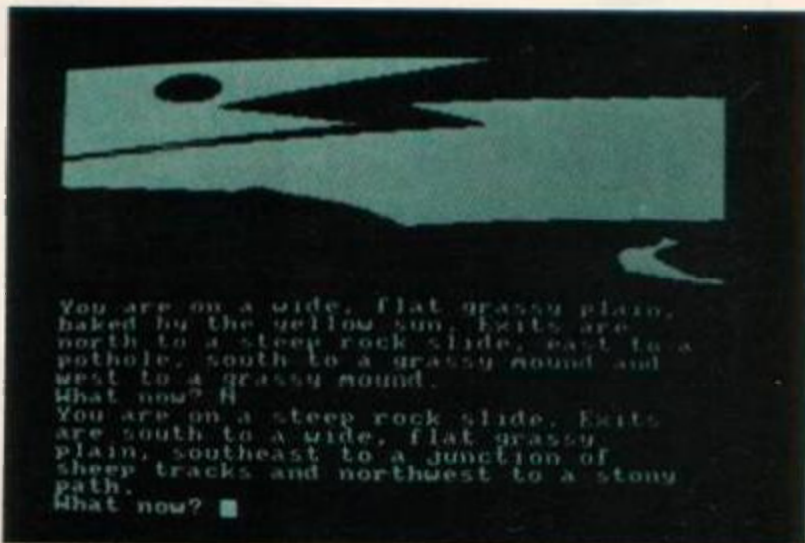

## The Price of Magik

After the success of *Red Moon*, Level 9 released *The Price of Magik* – a sequel to the earlier program but never quite as popular with reviewers (or with the Pilgrim). The problem with this game is that the locations aren't quite so spellbinding, but the adventure is saved from mediocrity by a large number of spells, each of which requires a "focus", or object that will enable the spell to be cast.

Your task in *Red Moon* was to regain the lost Red Moon Crystal and restore the source of magik to the realm – in *POM* the Crystal has been abducted by its guardian, Myglar, who, influenced by the power of the artefact, has dreams of immortality and supreme power (the usual thing). It's up to you to set things right by once again recovering the crystal and restoring order.

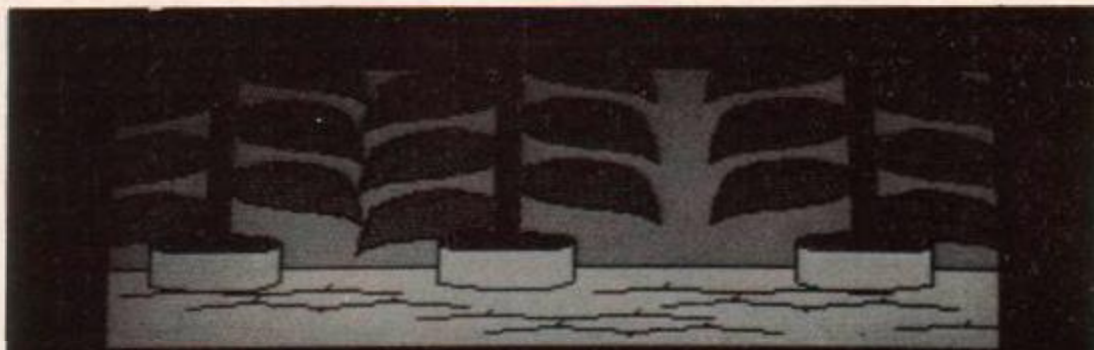

woodshed, upwards to a vine and in through a door. You can see a vine.  
 What now? W  
 You're in a woodshed in the swamp. Exits are east to a winding drive and west to a herb garden. You can see a candle and a woodpile.  
 What now? W  
 You're on a herb garden. An exit leads east to a woodshed. You can see an elder cross, a mandrake and some eyebright.  
 What now? █

## Lords of Time

This is the first game in the trilogy, but we're tackling it last for the simple reason that it is something of an odd-man-out. Although the other two titles tie together in an obvious fashion, the scenario of *Lords of Time* has little connection with them. Evil Timelords are attempting to pervert the course of history and you must travel through nine timezones and collect nine items with which to defeat them.

In many ways, *Lords of Time* is the best adventure in this collection, although the oldest. Since all the games have been "reprogrammed" - which means marginally more text in places, better parsing, and vastly improved graphics - the age of *LOT* (originally a text-only game) is never apparent. It was in fact one of the first games to be written by an outside author (a lady named Sue Gazzard) and she did a superb job. Not only are the textual descriptions delightful, but the separate zones each build up into a series of mini-adventures that enhance the challenge of the game and add to its long-term interest.

# Rod & Staff Monthly

A Newsletter for Wanderers

Edited by the Pilgrim. Price: Free to all Followers of the Straight and Narrow Path Issue 4

## Magnetic Scrolls Corrupted!

The gals and guys at Mag Scrolls are following up *Jinxter* with a game set in the world of high finance and corporate crookery. Framed by your business partner, threatened by assassination, and facing a jail sentence, you have to polish your shadier skills and practise ruthless character manipulation.



Unlike their previous games, which have (with the exception of the *Pawn*) been primarily concerned with finding and using objects, *Corruption* centres on the extraction of information from other characters and situations, as well as interaction with others to help achieve your objectives. This sounds like a welcome development in playing style, taking the company nearer to the character-interactive programming that has helped some of Infocom's best titles to the top of the adventure ladder.

The graphics are claimed to be even more stunning than *Jinxter* and *The Guild of Thieves*. The Pilg wonders whether this continual "improvement" is really possible - after a while, when graphic representation reaches the limits of palette exploitation and draughtmanship, you're unlikely to see any dramatic improvement in quality, but only differences in

## Adventure Probe Change

Adventure Probe, the energetic fanzine for wanderers produced by Sandra Sharkey has now got a new editor, Mandy Rodrigues, as Sandra has had to move onto other things...

Probe, as regular readers will know, receives the Pilg's blessings in this column from time to time. It claims to be a non-profit making business and from the amount of work involved I can imagine this probably means it's a loss-making business. Adventurers willing to give it some deserved support can contact Probe at 24 Maes Y Cwm, Llandudno, Gwynedd, LL30 1JE. The magazine comes out monthly with tips, solutions, and gossip and costs £1.25 per copy.

## Gnome Ranger 2

Hot on the news that the Adventurer's Club (64c Menelik Road, London, NW2) has voted *Gnome Ranger* into the number one slot for 1987 comes Level 9's announcement that *Gnome Ranger 2* is now being coded.

Details of the new title are being kept secret for the time being, but the Pilg can reveal that it will be another three-parter and "...as much fun as the first one" according to Pete Austin. Since the company have been hard at work finishing *Lancelot* (based on the Arthurian legends) for Mandarin, and since that particular subject is hardly a barrel of laughs, I think it's safe to predict that GR2 will be something of a safety valve for the quirky Austin sense of humour. You have been warned...

It's fair to say that *Time and Magik* is not such a "trilogy" as the two Rainbird packages mentioned earlier. The justification for putting the three games together is that they are "key episodes from the struggles of the Guardians to protect Time and Magik" – on which basis we could probably include a few other (say a couple of thousand) games as well. But who's complaining? At £14.95 it has to be one of the best bargains available.

If you already have one or even two of the titles, I'd say that *TAM* is still worth purchasing simply to get hold of the third. If you've played all three, it probably isn't, but I can't help feeling sorry for anyone who feels compelled to decide against adding this jewel to their collection.

Atmosphere 92  
Challenge 92  
Interaction 90  
Overall 92

## Perry's Piece

Andrew Perry gets his paws on PAW...

My copy of Gilsoft's *PAW* has just arrived, albeit around 5 weeks overdue. The delay was due to Gilsoft running out of manuals and having to wait for the printers to produce some more, which must mean it's selling reasonably well...

One thing worth mentioning about *PAW*, however, is its unfriendliness, due to CPM, on a 464/664 with a single disk drive. Although the software – what I've seen of it so far – is excellent and the documenta-

tion very comprehensive, its use of CPM does make it cumbersome in the extreme if you're limited to the above set-up. And, of course, you have to dust off your disk manual to use the various CPM utilities to copy disks, files and use PIP etc...

The other annoyance is that you need a word-processor or text editor to produce the source code for the program. Because you're using CPM, the best solution is to buy a CPM compatible package because the one provided within the system is basic in the extreme. If

you don't do this, you'll find yourself jumping continually between Amsdos and CPM which is, to put it mildly, annoying. Will the CPM version of Protex work on a single disk 464/664, I hear you cry? No, it won't.

Using my disk version of Protex under Amsdos, I'm concerned about file size problems and even with the ROM version (which again requires more financial outlay for a ROM board) the file size is limited and file linking may be required. However, since I haven't even started the coding of my epic *Dungeon Bash*, I'll solve that puzzle when I come to it...

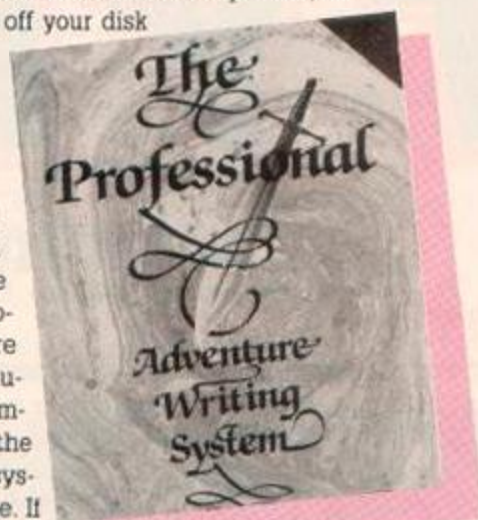

PROGRAMMING  
RETURNS NEXT  
MONTH

# Pilgrim Post

## Good news for GAC users!

Here's a Basic listing that allows you to use a new character set with GAC runnable data files (as in *Shymer* – see issue 32, page 66 – *Pilg*).

After running, the program will load the chr. file, followed by your adventure, which (as the program stands at the moment) MUST have the name **TESTR.ADV**, and then continue as normal.

The name of the adventure is held in line 100 (in hex ASCII format) and you can obviously substitute the codes for your own filename if required – remember that a filename has the format **FILENAME.EXT** and if you use less than eight letters for the first part, or less than three for the second, you must either pad the name out with spaces (character code 32 decimal, 20 hex) or else tell the program the total length (including the full stop separator) of the new filename. You can do that by altering the second hex value in line 90, which currently reads 0C hex (12 decimal) because in line 100 the name **TESTR.ADV** is actually stored as **TESTR[space][space][space].ADV**.

Last time I sent a listing to a magazine (*Home Computing Weekly*), it folded next week!

R.C. Moslin, Dunstable

Many thanks for your listing, Mr Moslin. Don't worry about *The Curse of Moslin* – AA is here to stay.

```
5 REM ***REM RUNDATA (C) 1988 NILSOFT BASIC LOADER
10 SYMBOL AFTER 32
15 LOAD R*your character file name*S, &9FFC
20 MEMORY &9FBF
30 ADD=&9FC0
40 WHILE V$<>SENDS
50 READ V$: POKE ADD, VAL(R&S+V$)
60 ADD=ADD+1
70 WEND
80 CALL &9FC0
90 DATA 06,0C,21,DD,9F,11,00,50,CD,77,BC,EB,CD,83,BC,21,E9,
```

```
9F,11,2C,1F,01,09,00,ED,B0,C3,2C,1F
100 DATA 54,45,53,54,52,20,20,20,2E,41,44,56 TTHIS LINE
CONTAINS THE FILENAME FOR YOUR ADVENTURE filename.ext
110 DATA 11,40,00,21,FB,9F,00,00,00
120 DATA END
```

## Aaargh!

As you drive around Somerset, you may have noticed various strange objects by the roadside at road junctions – helmets, shields, gold coins, skulls, jewels, etc. These are, as you probably realised, the traditional aids to route finding dropped by travellers in adventure games. The ones you have seen were left by poor lost wanderers in a large multi-user game, which has not yet been mentioned in your pages.

The participants have started from all parts of the world and having successfully negotiated spaghetti junction, the M25, and all the associated roadworks and contra-flows they are now converging on the southwest. (Some unfortunately were eliminated when they tried to use the Severn Tunnel instead of the Severn Bridge). They are now passing through Devon and approaching the final part of their journey.

They are of course adventurers who own a CPC464+DDI+64K RAM who ordered Magnetic Scrolls games on the Pilgrim's recommendation. After a long wait the game and AA Issue 32 dropped through the letterbox together and they discovered that the game would NOT run on a CPC464.

The object of the game is to cross the Tamar, avoid the Orcs hiding in disused tin mines, and find the Pilgrim's lair. Once there, persuade him to hand over large sums of cash which will be used to buy 40025 BASIC ROM chips for converting the aforesaid CPC464's.

You will understand that I daren't add a name and address – if I did I would soon have the Pilg's Balrogs and Nazgul's at the bottom of my garden.

Anon.

What can I say? Once again, I can only apologise profusely for the error, promise not to let it happen again, and reassure everyone (this correspondent included) that they need have no fear of the Balrogs, which are at this moment busy digesting the remains of the unfortunate individual who gave me the wrong information in the first place.

# TYPE-INS

Utility type-ins to make your micro move

## Magazine Editor

Johnnie Chan, of Studley has sent in a whole suite of programs. They were all good but two especially are worthy to be featured here. The first is a simulation of making the production decisions for a magazine.

Go through the questions, choosing the budget and contents. After these are decided your circulation figures are revealed. Sometimes back issues are snapped up if available, so don't be too afraid of over-production.

We just wish the real thing was as simple as this.

```

1 'Magazine Editor
2 'By Johnnie Chan
3 'Amstrad Action July 88
10 MODE 1:INK 0,0:INK 1,24:INK 2,6:INK 3,2 'initialise
20 WINDOW 1,40,10,15:PAPER 2:PEN 3:CLS:PRINT TAB(10)
   "MAGAZINE EDITOR":PRINT"enter name of magazine":INPUT
   a$:mag$=UPPER$(LEFT$(a$,40))
30 MODE 1:PAPER 0:PEN 1:PRINT TAB((40-LEN(mag$))/2)mag$:
   PRINT "CASH:":TAB(21)"READERS:":PRINT:PRINT"MAG
   COST:":TAB(21)"ISSUE no."
40 WINDOW#1,6,20,2,2:WINDOW#2,29,40,2,2:WINDOW#3,10,20,4,4:
   WINDOW#4,30,40,4,4:FOR t=1 TO 4:PEN#t,2:PAPER#t,3:CLS#t:
   NEXT
50 WINDOW 1,40,6,25:BORDER 0
60 cash=10000:GOSUB 260:is=0:re=0
70 WHILE cash>0 AND cash<1E+09 'game
80 is=is+1:GOSUB 100:WEND
90 PRINT"WELL DONE-You're a billionaire now!"
100 'make mag
110 CLS:INPUT"How much money for the mag cover(1-100)?£",cov:
   IF cov<1 OR cov>100 OR cov>cash THEN 110
120 cash=cash-cov:PRINT"Will you have a cover
   cassette(y/n)"
130 a$=UPPER$(INKEY$):IF a$="Y" THEN cas=0.4 ELSE IF a$="N"
   THEN cas=0 ELSE 130
140 PRINT"Will you have a poster(y/n)"
150 a$=UPPER$(INKEY$):IF a$="Y" THEN po=0.1 ELSE IF a$="N"
   THEN po=0 ELSE 150
160 PRINT"what type of paper :-":PRINT"1-low (10 for 1p)":
   PRINT"2-med (5 for 1p)":PRINT"3-good(2 FOR 1 p)"
170 a$=INKEY$:IF a$<"1" OR a$>"3" THEN 170
180 ty=VAL(a$):INPUT"how many pages (10-250)":a:IF a<10 OR
   a>250 THEN 180 ELSE p=a
190 cp=INT(10/ty):IF cp=3 THEN cp=2
200 INPUT"Make how many copies":a:a=ABS(a):IF a*(p/cp/100+
   0.1+cas)>cash THEN 200
210 mm=a:INPUT"Price of mag:£",cost:cost=ABS(cost)
220 mr=INT((cov+p+ty*50+(100-cost*10+cas*20+500)+po*100)/10
   ):PRINT"RATING IS :":mr:re=INT((re/INT(RND*2+1))+mr*
   (30cost*5+RND*20)+p*ty*10+RND*100+po*1000+RND*100*2):IF
   re>mm THEN .re=mm
230 IF cost>5 THEN re=0:PRINT"Too expensive!":GOTO 250
240 IF is>3 THEN ba=INT(RND*re/10):PRINT ba:"readers buy
   back issues":PRINT"gain=£":ba*cost:cash=cash+ba*cost
250 cash=INT(cash-(cov+p*cp/10000*mm)-(cas*mm+po*mm)+re*
   cost):a$=""
260 'update
270 cost=ROUND(cost,2):PRINT#1,USING("££#####.##");cash
280 PRINT#2,USING("#####. ");re

```

```

290 PRINT#3,USING("££#####.##");cost
300 PRINT#4,USING("#####. ");is
310 CALL &BB18:RETURN
320 END

```



## Automatic Menu

This excellent short program gives you the option of running any program using the cursor and copy keys. The program catalogues the present disk, and gives you a list to choose from.

Make your selection, and voila: much easier than trying to remember obscure filenames. You have **Stephen Stokes**, from Aylesbury to thank for this one.

```

1 'Menu
2 'Stephen Stokes
3 'Amstrad Action July 88
10 FOR z=10000 TO 10018:READ v:POKE z,v:NEXT z

```

```

20 MODE 2:CALL 10000:ly=VPOS(#0)-4
30 PRINT TAB(10);"Move the arrow with the cursor keys, then
press COPY to load"
40 f$=SPACE$(11):x=13:y=4:LOCATE x,y:PRINT CHR$(242);
50 IF NOT(INKEY(0)) AND y>4 THEN GOSUB 110:y=y-1:GOSUB 100
60 IF NOT(INKEY(2)) AND y<ly THEN GOSUB 110:y=y+1:GOSUB 100
70 IF NOT(INKEY(8)) AND x>13 THEN GOSUB 110:x=x-20:GOSUB
100
80 IF NOT(INKEY(1)) AND x<73 THEN GOSUB 110:x=x+20:GOSUB
100
90 IF NOT(INKEY(9)) THEN 120 ELSE 50

```

```

100 LOCATE x,y:PRINT CHR$(242);:FOR t=0 TO 100:NEXT:RETURN
110 LOCATE x,y:PRINT " ":RETURN
120 a=((ly-3)*((x-13)/20)+(y-4))*14+64001
130 POKE 10000,a MOD 256:POKE 10009,a\256
140 POKE 10011,PEEK((@f$)+1):POKE 10012,PEEK((@f$)+2):CALL
10007
150 f$=LEFT$(f$,8)+". "+RIGHT$(f$,3):CALL &BC7A
160 WHILE INKEY<>"":WEND
170 LOCATE 30,ly+6:PRINT"LOADING: ";f$:RUN f$
180 DATA &11,&00,&40,&CD,&9B,&BC,&C9,&21,&00,&00
190 DATA &11,&00,&00,&01,&0B,&00,&ED,&B0,&C9

```

## Tunnel

The second program from J. Chan is a graphics demo. The program asks for two numbers, which are used to draw a tunnel shape. Then the program animates, giving the impression of diving into the tunnel.

```

1 'Tunnel
2 'By Johnnie Chan
3 'Amstrad Action July 88
10 MODE 1:INK 0,0:BORDER 0:INK 1,16
20 FOR t=2 TO 14:INK t,24:NEXT:INK 15,26
30 INPUT"no. of sides",s
40 INPUT"how far apart",re
50 MODE 0:DEG:ORIGIN 320,200
60 FOR r=5 TO 405 STEP re
70 c=c+1:IF c>14 THEN c=1
80 MOVE 0,r:FOR t=0 TO 360 STEP 360/s:DRAW r*SIN(t),r*COS
(t),c:NEXT
90 NEXT
100 GOSUB 140
110 i=i+1:IF i>14 THEN i=1
120 INK i,26:FOR t=1 TO 30:NEXT:FRAME:INK i,0
130 GOTO 110
140 REM display
150 ORIGIN 0,0
160 MOVE 1,1:DRAW 639,1,15:DRAW 639,70:DRAW 1,70:DRAW 1,1:
FOR t=4 TO 635:MOVE t,2:DRAW t,69,0:NEXT
170 po=50:GOSUB 190

```

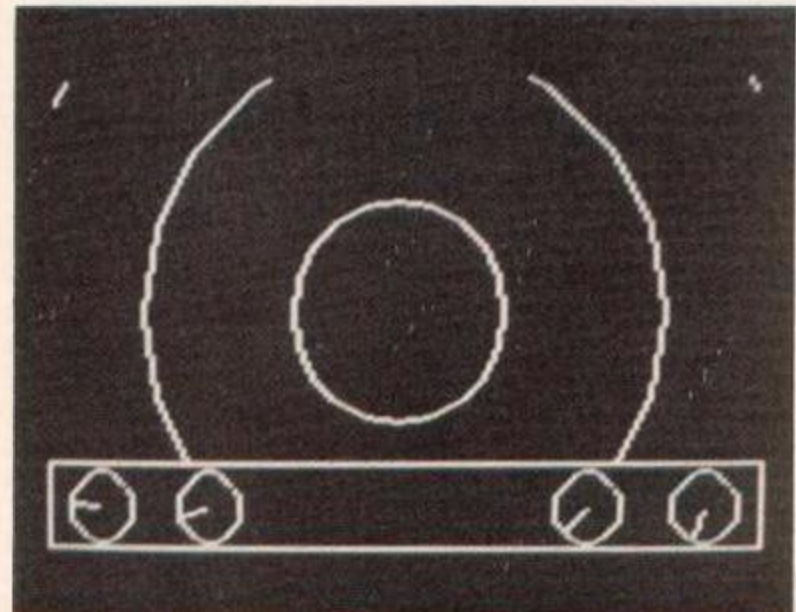

```

180 po=490:GOSUB 190:RETURN
190 FOR n=po TO po+100 STEP 100:ORIGIN n,35:MOVE 0,30:FOR
t=0 TO 360 STEP 10:DRAW 30*SIN(t),30*COS(t),15:NEXT:FOR
t=0 TO 360 STEP 25:MOVE 0,0:DRAW 27*SIN(t),27*COS(t),c:
c=c+1:IF c>14 THEN c=1
200 NEXT:NEXT:RETURN
210 END

```

## Fame and fortune

Interested? Yes? Well, if you send us your programming masterpieces and they subsequently get published in these pages, you could stand to win £100. And your name would be seen by thousands of Amstrad addicts. What more could you ask for? Every person whose listing appears in the Type-Ins section is guaranteed anything from £10 to £100. What's the catch? None. We simply want your listings. Send them – together with your name, address and a jiffy bag (for return) – to "Type-Ins", Amstrad Action, Future Publishing Ltd, 4 Queen Street, Bath, BA1 1EJ.

If you plan to send a listing to be considered for publication, here are a few pointers:

- Make sure it's your own original, unpublished work.
- Use lower-case rather than capitals for variable names.
- REM statements make the program easier to understand.
- Do not use letters that look like numbers as variable names (O and 0, l and 1 for example).
- Structure your program – divide it into sensible procedures.
- Avoid long multi-statements. Short lines make debugging easier.
- Please make sure your name and address is on every slip of paper, cassette or disk that you send us

## Byte Search

This utility by J Longley from Tonbridge sets up a handy RSX command. When invoked it will scan through memory looking for a particular set of bytes. If it finds that string of bytes it prints the address where the string was found.

To use it simply type in:

```
|SEARCH,Byte 1,Byte 2...Byte n,Start Address, Finish Address
```

For example:

```
|SEARCH,33,0,0,&1000,&BE00
```

```

1 'Byte Search
2 'By J Longley
3 'Amstrad Action July 88
10 MEMORY &9FFF:add=&A000
20 FOR f=100 TO 290 STEP 10
30 chk=0:FOR g=1 TO 16
40 READ a$:a=VAL("&"+a$)
50 POKE add,a:add=add+1:chk=chk+a
60 NEXT
70 READ b$:IF chk<>VAL("&"+b$) THEN PRINT "Error in line
";f:END
80 NEXT
90 CALL &A000:PRINT "|SEARCH,<List of bytes>,start,finish"

```

## AMSTRAD COMPUTER REPAIRS

Fixed Price repairs

From £10 inclusive of VAT, P&P, and 3 months "NO QUIBBLE" guarantee  
Send your computer to:-

The Computer Factory (Dpt.AA01),  
Analytic Engineering Limited  
Unit 18a, Grainger Road Industrial Estate,  
Southend-on-Sea SS2 5DD

We will then give a no obligation fixed price quotation. If you want to proceed, fine, if not, we will return the machine by the next post at our expense.

If you prefer to telephone in the first instance for an informal chat:-

TELEPHONE (0702) 618455

Also available, massive software selection  
TELEPHONE (0702) 618455 for FREE LIST

Most computers are covered by our comprehensive deal. These include:-

SINCLAIR - COMMODORE - BBC etc.

TELEPHONE (0702)618455 for details.

## budgetsoft

Send for full Price List

SALE FOR LEASING (PC/PCW and PC1512)

<b>£1.95</b>	MAGIC WREST BOULDERDASH AVENGER BOUNDER JACK THE HUNTER KRAKOUT FLYING KNIGHT GRANDE HILL IMPOSSIBLE MATHS ACCOLADES	SUPERLEVIN SUNSHINE MORRIS'S QUEST REACTOR GENERATOR ZIG ZAG DUEL ATRAID KONFRATU CALCIPON'S SHOOTWAY KICK ELEVATOR ACTION LEATHORN ELECTRA GLOBE PUB GAMES KRAKOUT SPINZITZ SABOTAGE TWO ON TWO BASKETBALL SAULING BIG TRAIL IN LITTLE CHINA BILLYBLAZER HACKER ACTION FIVE 1 JAIL BREAK HARBOR 10 KICKING 30 STUNT KICKS 4 HOGS, POOL & SHOOTER MAGIC SUPERSTAR	WINTER OLYMPIE S.A.S. BEACH HEAD 2 YES ARE KUNG FU STREET MACHINE SPY 1 SPY TWINARK AIR WRECKER CONVOY RACER BLACKMAGIC EXPRESS RACER SIMPARTS SARACER SUMBLER KILLED UNITS DEAD PROFIT GAMES 1 SURVIVOR YE AR KUNG FU STAR GAMES ONE DRAGONS LARK DORRO SKYDOL KNIGHT RIDER DAY DARE WINTER SPORTS MAGIC VALLEY GAMES CHUCKS 150 CHUCKS 200 VIRAM SALING BOING NOW GAMES 4 MICROVALVE VOL 2 WAY OF THE TIGER	SPACE SHUTTLE KUNG FU MASTER GAI WAR GAUNTLET <b>£5.95</b> QUARTET PRESTIGE COLLECTION SUPER SPINNY FRICTY STAR RAZERS 2 HSE MYSTERY OF NILE STRIKE FORCE HARBOR BAGGLES SPYTRIX 40 TANK OF DEEP ACTION FIVE 10 MAGIC VALUE 3 SAL GEMBAT JEWELS OF DARKNESS CON-OF-CLARICE INFILTRATOR ROAD RUNNER SUMMER SOLD WINTER GAMES ROCKWRESTLE SHOGUN SPADEZITZ KID ARROW (DSC) TRABULANT (DSC)	MOLLY'S KEY KING TRAVISA KOHAN JONES <b>£6.95</b> HYPOGOGG TRANDOGG TRANDOGG LORD OF THE RINGS STANGLER BRILLIANT (DSC) HACKER (DSC) LITTLE COMPUTER PEOPLE HOWARD THE DUCK & MORGAN BOING (DSC) <b>£9.95</b> SABESALONG GFL FOOTBALL (DSC) BASKETBALL (DSC) 10 GREAT GAMES BLACKMAGIC (DSC) EXPRESS RACER (DSC) INFILTRATOR (DSC) KILLED UNITS DEAD (DSC) ROAD RUNNER (DSC) SARACER (DSC) WINTER GAMES (DSC) INTERNATIONAL KARTING (DSC) MATHS ACCOLADES (DSC) PUB GAMES (DSC) COMPUTER SPREAD SHEET TEACH YOURSELF BASIC VOL 1 FEEL THE TRIAL PAPER TEACH YOURSELF BASIC
--------------	---	--	--	---	--

Post and packing: 1-3 titles 75p, 4 or more £1. Overseas £1.30 per title.  
PERIPHERALS: £1 per item. Overseas £1.80  
Please send cheque/P.O.'s to: Budgetsoft, Dept AA, 33 Little Breoch,  
Chichester, W.Sussex, PO19 4TY.

**BBD**  
DUST  
COVERS

## GET SMART

**BBD**  
DUST  
COVERS

Protect Your Computing Equipment With  
**BBD PROFESSIONAL DUST COVERS**

- In today's economic climate where equipment failure costs time and money protecting your hardware from wear and tear is the smart thing to do and the smart way to do it is with dust covers from the BBD Professional Range.
- Manufactured from top quality washable nylon and attractively finished with contrasting piping BBD covers are simply the smartest protective covers available.
- BBD covers can be washed and ironed without fear of fading or shrinking and will never crack or lose their shape.
- With all these superlative features you might expect BBD covers to be a little expensive. Nothing could be further from the truth.

Covers for the **AMSTRAD CPC 464** : £7.50  
Covers for the **AMSTRAD CPC 6128** : £7.50  
Please state Colour or Monochrome Monitor

- BBD also offer a wide range of matching covers for the printers from only £5.00.
- These include Amstrad DMP 2000, 3000 and 3160, Amstrad DMP 4000 and LQ3500, and a selection from Brother, Canon, Citizen, Epson, Star etc. etc. Generally covers for 80 column printers are £5.00 and for 132 column £6.00

**GET SMART! GET BBD!**  
**BBD DUST COVERS**

The Standish Centre,  
Cross Street, Standish, Wigan WN6 0HQ  
Telephone: 0257 422968 Ext.321 Fax: 0257 423909



DEALER ENQUIRIES WELCOME



Unbeatable value

**CPC464  
CPC664  
CPC6128**

## MONEY MANAGER

SAVE £5 on RRP of £29.95 when you order direct from Connect Systems

**ONLY £24.95**

Incl. VAT, P&P

Financial management software for personal and/or small business use

Money Manager is an easy-to-use system for recording all financial transactions, and for analysing them in a number of very powerful ways in order to facilitate sound financial management. It is ideal for controlling the finances of a small business, or for users wishing to control their personal finances in a business-like way. Use it to check bank statements, keep track of expenditure, monitor cash flow, make budgeting forecasts, prepare business financial statements, pacify your bank manager, convince the tax and VAT inspectors, avoid nasty surprises, etc. etc.!

12 months of entries are kept in a file stored on your disc. At any time, you may load a file into the computer memory, add to or edit the entries, analyse them, print statements, and then save the updated file for later use. Entries may be historic (for record keeping) or forecast (for budgeting). You may have any number of separate files, and make copies of files for archive purposes. You may advance the period covered by a file month by month.

Up to 100 separate transactions may be entered per month. Each entry consists of:

- The day of the month, e.g. 23rd of June.
- An account number, one of up to 9 defined by you to suit your circumstances e.g. 1=Barclays, 2=Visa, 3=Halifax etc.
- Reference, e.g. ABC123 for a cheque number or invoice reference.
- A class code, one of up to 50 defined by you to suit your circumstances e.g. h0=Household expenses, h1=Mortgage, h2=Rates or p0=Production, p1=Raw materials, p2=Assembly, p3=Packing, etc.
- A description so that you can see what each transaction was for, e.g. "New gearbox" or "Box of 10 discs."
- An optional single character mark which you may include for further classification, e.g. b=business, p=private, etc.
- The amount of the transaction, which may be plus or minus.
- A marker to indicate whether the entry is exempt, zero rated or taxable for VAT, or alternatively the actual VAT paid.

You may select categories according to account, class and mark (e.g. all entries, or all motoring expenses for business using a credit card, etc.) and produce reports on the screen or printer as follows:

- Full detailed statements, showing each transaction for any month or for the whole year.
- Detailed monthly VAT statement showing input and output amounts excluding VAT, the actual VAT and the total amount, plus totals and net VAT due.
- Tables showing the totals in each class for each month of the year.
- Tables showing the totals in each class for each account.
- Tables showing monthly maximum, minimum, average balances, turnover, cashflow etc.
- Bar graphs of any category month by month.
- Pie charts of annual totals for various categories (CPC version only).

Plus: standing orders—entries optionally sorted into date order—item search facility. Comprehensive manual and full set of practice data included. Full telephone support.

Send cheque or credit card number or phone for immediate despatch

## Connect Systems

3 Flanchford Road, London W12 9ND. 01-743 9792 8am-10pm 7 days a week





```

120 DATA 01,0D,A0,21,09,A0,C3,D1,BC,00,00,00,00,12,A0,C3,53D
110 DATA 35,A0,53,45,41,52,43,C8,00,21,25,A0,7E,B7,C8,CD,6BB
120 DATA 5A,BB,23,18,F7,50,61,72,61,6D,65,74,65,72,20,65,66D
130 DATA 72,72,6F,72,00,FE,03,38,E0,F5,DD,6E,00,DD,66,01,76C
140 DATA 22,2D,A1,DD,6E,02,DD,66,03,22,2B,A1,F1,3D,3D,32,60E
150 DATA 30,A1,DD,23,DD,23,47,DD,23,DD,23,10,FA,21,31,A1,715
160 DATA 47,DD,5E,00,73,23,DD,2B,DD,2B,10,F5,3E,00,32,2F,5CC
170 DATA A1,2A,2B,A1,01,31,A1,56,0A,92,20,06,03,18,23,23,3E3
180 DATA 18,09,23,3E,00,32,2F,A1,01,31,A1,E5,ED,5B,2D,A1,552
190 DATA ED,52,E1,28,51,3E,42,C5,E5,CD,1E,BB,20,6C,E1,C1,897
200 DATA 18,D5,E5,21,2F,A1,34,56,3A,30,A1,92,E1,20,D0,E5,7A0
210 DATA 3A,30,A1,3D,28,06,C5,47,2B,10,FD,C1,18,0A,AF,32,57E
220 DATA 2F,A1,E1,01,31,A1,18,B7,11,D5,A0,1A,B7,28,0B,CD,6AA
230 DATA 5A,BB,13,18,F6,20,3E,3E,20,00,7C,11,E0,A0,18,0A,521
240 DATA 7D,11,BE,A0,18,04,18,3D,18,B4,C5,06,02,4F,1F,1F,483
250 DATA 1F,1F,E6,0F,FE,0A,30,07,C6,30,CD,5A,BB,18,05,C6,62D
260 DATA 37,CD,5A,BB,79,10,EB,C1,D5,C9,3E,42,CD,1E,BB,20,832
270 DATA F9,3E,42,CD,1E,BB,20,09,3E,12,CD,1E,BB,28,F2,18,670
280 DATA C7,E1,C1,18,00,CD,09,BB,38,FB,C9,00,00,00,00,60E
290 DATA 00,00,00,00,00,00,00,00,00,00,00,00,00,00,0
300 END

```

## Rodos Catalogue

If you have Rodos, you could well find this program very useful. It scans through a disk's directory, searching for all the branches. These can then be printed out to your screen and printer. Saves a lot of messing about with the system, I find.

A word of warning: the disk must contain no Linked files, otherwise the program gets terribly confused. Richard Jones from Cheshire created this.

```

1 'Rodos Catalogue
2 'Richard Jones
3 'Amstrad Action July 88
10 PEN 1:PAPER 0:MODE 1:BORDER 0:INK 0,0:INK 1,26:INK 2,6:
   INK 3,24:WIDTH 40
20 REM
30 |PRINT,0:REM Change this line to |PRINT,2 to send the
   data to the printer.

```

```

40 REM
50 DIM t%(40),s%(40),p%(40):tr=0:t%(0)=0:s%(0)=481:p%(0)=
   4104:MEMORY 47FFF
60 PEN 1:PRINT"          RODOS disc tree reader          ":
   PEN 2:PRINT"          -----          ":
   PEN 3:PRINT"by Richard Jones":PEN 1
70 |READSECT,48000,0,0,481:PRINT:PRINT"Title: ":FOR f=
   48002 TO 48011:PRINT CHR$(1);CHR$(PEEK(f));:NEXT:
   PRINT:PRINT
80 GOSUB 130
90 END
100 REM
110 REM MAIN LOOP - the program calls this subroutine to
   print out a directory full of data
120 REM
130 |READSECT,48000,0,t%(tr),s%(tr)
140 pn=p%(tr)
150 IF pn>=4100 THEN 300
160 IF PEEK(48000+pn)>47F THEN GOTO 190
170 PRINT SPACE$(tr*2);FOR f=48000+pn+1 TO 48000+pn+410:
   PRINT CHR$(1);CHR$(PEEK(f));:NEXT:PRINT " ";:IF PEEK
   (48000+pn)=42C THEN PRINT"Dir" ELSE PRINT"Data"
180 IF PEEK(48000+pn)=42C THEN GOSUB 240
190 pn=pn+32:GOTO 150
200 RETURN
210 REM
220 REM This routine is called to drop down further into
   the directory tree.
230 REM
240 p%(tr)=pn:tr=tr+1:t%(tr)=PEEK(48000+pn+412):s%(tr)=
   PEEK(48000+pn+413):p%(tr)=44
250 GOSUB 130
260 tr=tr-1:|READSECT,48000,0,t%(tr),s%(tr):pn=p%(tr):
   RETURN
270 REM
280 REM This routine deals with the RODOS extended
   directory system.
290 REM
300 IF PEEK(481E4)<>42 THEN GOTO 200
310 t%(tr)=PEEK(481E5):s%(tr)=PEEK(481E6):p%(tr)=44:GOTO 130
340 END

```

## Poly Stars

A graphics shortie is this. It can draw stars with any number of points - hardly world shaking, but try it. Enter some decimal fractions for some interesting variations. Jakob Givoni from Denmark wrote this one.

```

1 'Poly Stars
2 'By Jakob Givoni
3 'Amstrad Action July 88
10 INK 0,0:INK 1,24:MODE 2:PAPER 0:CLS:BORDER 0
20 DEG
30 INPUT "How Many Tops":t
40 INPUT "How Many Lines":s
50 DIM bonex(s),boney(s),btwox(s),btwoy(s)
60 cx=320:cy=200
70 bonex=cx+200*COS(0):boney=cy+200*SIN(0)
80 btwox=cx+200*COS(360/t):btwoy=cy+200*SIN(360/t):CLS:
   c=360/t
90 LOCATE 1,25:PRINT "Press any key to continue"
100 WHILE INKEY$=""
110 MOVE bonex,boney:DRAW cx,cy,1:DRAW btwox,btwoy
120 FOR a=1 TO s
130 bonex(a)=cx+(bonex-cx)/s*a
140 boney(a)=cy+(boney-cy)/s*a
150 btwox(a)=cx+(btwox-cx)/s*a
160 btwoy(a)=cy+(btwoy-cy)/s*a
170 NEXT
180 FOR a=1 TO s
190 MOVE bonex(a),boney(a):DRAW btwox(s-a+1),btwoy(s-a+1),1

```

```

200 NEXT
210 c=c+360/t
220 bonex=btwox:boney=btwoy:btwox=cx+200*COS(c):btwoy=cy+
   200*SIN(c)
230 WEND
240 RUN
250 END

```

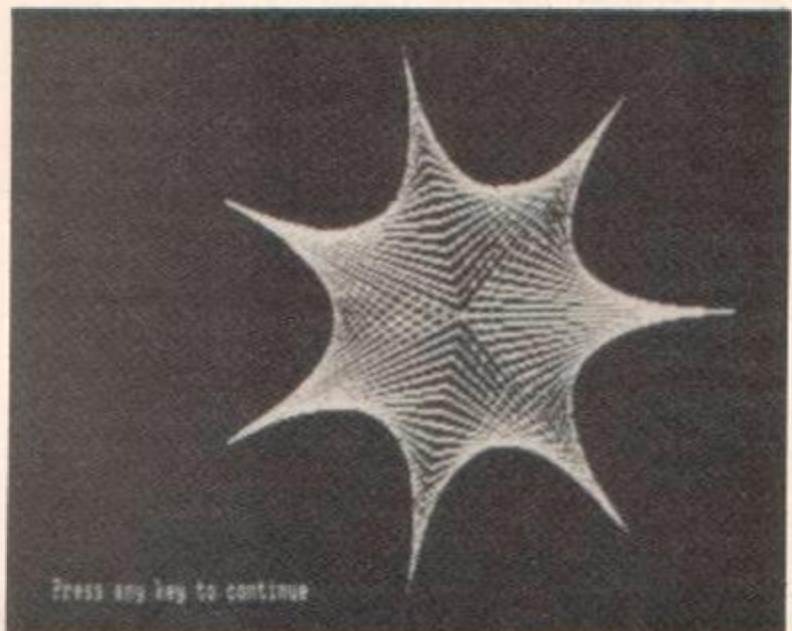

## Desert Attack

Now for something slightly different. Drive your tank in a lone rescue bid. Blast everything you can except the brown canisters - these are your only source of extra ammunition. After approximately 2500 miles you will see the hostage hut. Shoot it to free them and win.

Use the left and right cursors, and space to fire. This is the work of Gavin Jones of Cardiff.

```

1 ' Desert Attack
2 ' By G.Jones
3 ' Amstrad Action June 88
10 'Initialize
20 SYMBOL AFTER 256:MEMORY 39999:SYMBOL AFTER 246
30 FOR addr=40000 TO 40019
40 READ a$:POKE addr,VAL("&"a$)
50 NEXT
60 DATA dd,6e,02,dd,66,04,cd,75,bb,cd
70 DATA 60,bb,dd,6e,00,dd,66,01,77,c9
80 '
90 SYMBOL 246,16,56,124,254,238,238,238:SYMBOL 247,16,56,124
,254,130,130,130,130
100 SYMBOL 248,16,16,84,254,186,186,198,124:SYMBOL 249,0,0,40,56
,16,16,16,0:SYMBOL 250,0,16,16,16,56,40,0,0:SYMBOL 251,56,124
,254,124,254,84,16,56
110 SYMBOL 252,20,8,20,56,124,124,124,56:SYMBOL 253,0,0,56,126
,126,255,255,255:SYMBOL 254,126,255,255,195,255,195,255,255:
SYMBOL 255,0,0,0,24,36,36,36,60
120 MODE 1
130 INK 0,15:PAPER 0:BORDER 15:INK 1,0:INK 2,21:INK 3,3:PEN 1
140 tnk$=CHR$(15)+CHR$(1)+" "+CHR$(248)+" "
150 eblt$=CHR$(15)+CHR$(1)+CHR$(249)+CHR$(8)+CHR$(11)+" "
160 yblt$=CHR$(15)+CHR$(1)+CHR$(250)+CHR$(8)+CHR$(10)+" "
170 trt$=CHR$(15)+CHR$(2)+CHR$(251)
180 hmb$=CHR$(15)+CHR$(1)+CHR$(252)
190 bldr$=CHR$(15)+CHR$(3)+CHR$(253)
200 trrt$=CHR$(15)+CHR$(1)+CHR$(254)
210 am$=CHR$(15)+CHR$(3)+CHR$(255)
220 expl$=CHR$(15)+CHR$(3)+CHR$(238)
230 ENV 1,10,-1,7
240 scr=0:mis=0:amo=100:lvl=1:x=20
250 'Main Loop
260 CLS
270 no=0
280 IF no=lvl THEN 320 ELSE 290
290 LOCATE INT(RND*39)+1,1:PRINT trt$:LOCATE INT(RND*39)+1,1:PRINT
bldr$
300 IF INT(RND*20)>18 THEN LOCATE INT(RND*39)+1,1:PRINT hmb$
310 no=no+1:GOTO 280
320 IF INT(RND*100)>97 THEN LOCATE INT(RND*39)+1,1:PRINT am$
330 IF INT(RND*25)=24 AND mis<2476 AND eby=0 THEN LOCATE x+1,1:
PRINT trrt$:ebx=x+1:eby=3:SOUND 3,0,0,12,1,,5
340 IF mis=2476 THEN PEN 1:LOCATE 20,1:PRINT CHR$(246)
350 IF INKEY(8)◊-1 OR INKEY(74)◊-1 THEN x=x-1
360 IF INKEY(1)◊-1 OR INKEY(75)◊-1 THEN x=x+1
370 IF INKEY(47)◊-1 OR INKEY(76)◊-1 OR INKEY(77)◊-1 THEN bx=
x+1:by=24:amo=amo-1
380 IF amo<=0 THEN bity=0:amo=0
390 IF x=0 THEN x=1
400 IF x=38 THEN x=37
410 IF by>0 THEN 420 ELSE 430
420 LOCATE bx,by:PRINT yblt$:by=by-1:LOCATE bx,by:PRINT yblt$:IF
by=1 THEN by=0:LOCATE bx,by+1:PRINT " ":GOTO 430
430 IF eby>0 THEN 440 ELSE 450
440 LOCATE ebx,eby:PRINT eblt$:eby=eby+1:LOCATE ebx,eby:PRINT
eblt$:eby=eby+1:IF eby=25 THEN LOCATE ebx,eby:PRINT " ":eby=0:
GOTO 450
450 LOCATE x,25:CALL &BD19:PRINT tnk$
460 LOCATE 1,1:CALL &BD19:PRINT CHR$(11)
470 mis=mis+4:scr=scr+5
480 IF mis=lvl*500 THEN lvl=lvl+1

```



```

490 IF mis>2580 THEN 1000
500 'Collision Detection
510 bti=0:CALL 40000,x+1,25,@bt
520 IF bti=32 OR bti=238 OR bti=250 OR bti=255 THEN 530 ELSE 1040
530 IF bti=255 THEN amo=amo+25:SOUND 2,50
540 IF by=0 THEN 700 ELSE 550
550 bti=0:CALL 40000,bx,by,@bt:cit=0:CALL 40000,bx,by-1,@ct
560 IF bti=251 THEN scr=scr+5:GOTO 620
570 IF bti=252 THEN scr=scr+5:GOTO 620
580 IF bti=253 THEN scr=scr+5:GOTO 620
590 IF bti=254 THEN scr=scr+10:GOTO 620
600 IF bti=246 THEN 730
610 GOTO 630
620 LOCATE bx,by:PRINT expl$:LOCATE bx,by+1:PRINT " ":by=0:SOUND
3,0,0,12,1,,31:GOTO 700
630 IF cit=251 THEN scr=scr+5:GOTO 690
640 IF cit=252 THEN scr=scr+5:GOTO 690
650 IF cit=253 THEN scr=scr+5:GOTO 690
660 IF cit=254 THEN scr=scr+10:GOTO 690
670 IF cit=246 THEN 740
680 GOTO 700
690 LOCATE bx,by-1:PRINT expl$:LOCATE bx,by+1:PRINT " ":by=0:SOUND
3,0,0,12,1,,31:GOTO 700
700 LOCATE x,25:PRINT tnk$:GOTO 270
710 GOTO 270
720 'End
730 LOCATE bx,by:PRINT CHR$(247):GOTO 750
740 LOCATE bx,by-1:PRINT CHR$(247)
750 LOCATE x,25:PRINT tnk$:LOCATE bx,by+1:PRINT " "
760 scr=scr+5000
770 FOR a=0 TO 500:NEXT a
780 CLS
790 PEN 1:LOCATE 15,3:PRINT"CONGRATULATIONS":PEN 3
800 LOCATE 1,5:PRINT"YOU TRAVELLED THROUGH ENEMY TERRAIN FOR"
810 LOCATE 1,7:PRINT"2500 MILES TO RESCUE THE HOSTAGES THEY"
820 LOCATE 1,9:PRINT"ARE EXTREMELY GRATEFUL TO YOU YOU ARE"
830 LOCATE 1,11:PRINT"HEREBY PROMOTED TO POSITION OF GENERAL!"
840 RESTORE 930
850 DIM tn%(17),ln%(17)
860 FOR a=0 TO 17
870 READ tn%(a)
880 NEXT a
890 FOR a=0 TO 17
900 READ ln%(a)
910 NEXT a
920 FOR a=0 TO 17:SOUND 1,tn%(a),ln%(a),15:NEXT a
930 DATA 159,0,159,142,169,159,142,127,0
940 DATA 127,119,127,142,159,142,159,169,159
950 DATA 60,1,60,60,90,30,60,60,1
960 DATA 60,60,90,30,60,60,60,60,180
970 WHILE (SQ(1) AND &80)◊0:WEND
980 ERASE tn%,ln%
990 GOTO 1050
1000 'You failed
1010 CLS
1020 PEN 1:PRINT"You have failed the mission but..."
1030 FOR a=1 TO 1500:NEXT a
1040 'Another go?
1050 CLS
1060 PEN 1:LOCATE 3,5:PRINT"You Travelled "':PEN 2:PRINT mis:
PEN 1:PRINT" miles"
1070 LOCATE 3,10:PRINT"You Scored "':PEN 2:PRINT scr:':PEN 1:PRINT
" points"
1080 LOCATE 3,15:PRINT"You had "':PEN 2:PRINT amo:':PEN 1:PRINT
" ammo left"
1090 PEN 3:LOCATE 15,20:PRINT"Another go?"
1100 IF INKEY(43)◊-1 THEN 1130
1110 IF INKEY(46)◊-1 THEN END
1120 GOTO 1100
1130 ebx=0:eby=0:bx=0:by=0:GOTO 240

```

# AA small ads

## FOR SALE

**Amstrad 6128** colour monitor, cassette recorder, volumes of magazines, 100+ games on tape and disc, including G.A.C. Gryzor, Matchday II, Renegade, Combat School, plus Screenvision TV £330 (ono). Tel: 01-450 8333

**CPC 464** with colour monitor, Quickshot II joystick and 18 top games. In good condition at £249. Phone Steve on 01-994 2808

**Slimming - By Computer?** Calorie Counter could help you. Lists basic foods and caloric value. Allows entry of new foods and daily intake. Reports calories used/remaining. Plus slimming help file. On disc for 6128 £8.95. From S.J. Simmonds, 4H Barke Road, Seafar, Cumbernauld, G67 1AL

**Discount cassette magazine.** The Hemel office of discount publishes a monthly magazine, including free games! Send £1 coin + SAE for issue 1 to - Discount (AA), 21 Gleaview Gardens, Hemel Hempstead

**Amstrad CPC 464,** colour monitor, disc drive, Multiface Two, plenty of software, books, £275 ono. Phone Harry on Watford 35009 anytime.

**Database and Word Processor CPC 6128** only. These are real quality programs. Database takes 64K data in RAM. Includes AA part index as demo. Word Processor has many powerful features and will print pages for your personal organiser. Plus Printcat File Directory, automatically printed as disc relay cards. Together on disc for £30. Alan Sharp, 73 Manor Avenue, Aberdeen, AB2 7UT

**CPC 464,** colour monitor, joystick and games. All excellent condition. £220 ono. Ask for Azar. Tel: 021 773 8843. 75, Charles Road, Small Heath, Birmingham, B10 9EF

**Infocom adventure games,** selection of as new £10 each, please ring Jeremy on daytime 0977 702581 night 0977 88885

**CF2 disc printed labels,** £1.10p/25, £2.00p/50, £3.50p/100. Printed index cards for CF2 plastic disc case, £1.00/10, £2.00/25, £3.00/50. Printed red or blue, please specify (may be mixed). Cheques/P.O.s to: Mr S Tonks, Audio & Computing Supplies, Unit 106, 266-290 Wincolmelee, Hull HU2 0PZ

**Amstrad software** for sale. All at very low prices. All software is original. Please send for a price list. Send a SAE to Martin Joyce, 98 St Johns Road, Wembley, Middx, HA9 7JN

**CPC6182** (colour), DMP2000 printer, blank discs, £300 of original disc software. Protex, GAC, Sentinel, Gauntlet, Trivial pursuit and many more. Great bargain £350. Philip

Birtwistle, 6 Colbran Street, Burnley, Lancs

**Amstrad CPC6128,** printer, Stop Press, music machine, Speech synthesiser, Disc Wizard, joystick, 70 original games. 50 on disc, 20 blank discs, magazines £450 ono. Will sell separately. Enquiries Flimwell (0580 087) 535.

**Amstrad CPC6128** colour monitor, DMP 2000 printer, Pace modem - Interface - software, Multiface Two. Tape deck, Business & games software & manuals, over 20 disks & 20 tapes & storage boxes. Cost over £1000. Will accept £500. Phone 0268 781185 after 6pm.

**Memodex Ramdisc** (software). Stores 5 banks of 16K Basic programs on your CPC6128/464+DKRAM, knowledge of BASIC assumed. Disc £9.50, Tape £7.50 (transferable). State machine, send cheques/P.O.s to YSIEW, 57 Foundry Lane, Freemantle, Southampton SO1 3FX

**CPC Business software** on disc: Sales & Purchase Ledgers, VAT, Stock Control, Mailing List/Labials etc all for £24.95. "Small Business Booster - Has the lot" (AA26). Sales Invoicing only £19.95 (£9.95 with pack). General Ledger (computerised cash book) £19.95 (£14.95 with pack). All fully menu-driven & Epson compatible. Cheques, P.O.s or SAE for details. SD Microsystems (AA), PO Box 24, Hitchin, Herts. Phone (0462) 675106

**Blank Amsoft J' discs in cases:** 5 for £12.00, 10 for £21.95. Send cheques/P.O.s to First Byte Software, PO Box 50, Yeovil, Somerset, BA20 1XS

**Multiface II** as new. Cost £44.00 accept £25.00. Also Graphic Adventure Creator (CPC464) plus extra GAC book £15.50. Tel Kevan (0295) 3654

**Colour 464,** joystick, mags, books, £300 worth games, dust cover, good condition. All worth £800, sell for £225 ono. Telephone 0737 351355. Will deliver within reasonable distance.

**PD disk of AMSDOS** original and CP/M software. Gallery, programming, adventure, fonts, electronics, etc £4.50. Mark envelope AA. Paul Brown, 19 Wren Road, Sidcup, Kent, DA14 4LY

**Steve's Services** \* Built 2nd disc drive, compatible with Amstrad first disc drive. All cables supplied. Only £78.99 including postage. 40 Finmore, Bracknell, Berks, RG12 4WF. or telephone (0334) 425766

**Maths Master,** solves 10+ mathematical problems. Includes: Trigonometry, Geometry, Quadratic Equations, simple and compound interest, logarithms, simple arithmetic. send £3 (IR£4). Jeremy Craine, 30 Abbey Park, Arklow, County Wicklow, Ireland

**Colour CPC 464** DD11, Multiface 2, joysticks, 300+ software (disc and tape) Driller, Gauntlet 1/2, Mag Max, Spy v Spy Tril, GAC, Renegade. Sei for £450. D Palmer, 1 Helmsboro Ave, Moonside, Oldham, Greater Manchester OL4 2OB

**Young software products** Educational games for 6128 owners. Ideal for 7-14 year olds. Send SAE for brochure to: 5 Hartlyn Drive, Pinner, Middx HA5 2DF

**Colour 464,** software, books, magazines, joystick, dust covers, machine code assemblers, worth £1100. Sell for £600 or separately. Phone Dave (0569) 65609

**Calorie Controller could help you slim.** Built in data. Search for foods and caloric value. Enter new foods - calculate daily intake. Reports calories used/remaining. List ingredients. Weight records. Ideal weights etc. Met/Imp versions. Slimming help file. Disc CPCs and PCWs. £12.50. SAE for full details. S J Simmonds, 4H Barke Road, Seafar, Cumbernauld G67 1AL

**Steve's Services** produce a wide selection of hardware. From extension cable to disc drives. Send a SAE for the latest price list. Steve's Services, 40 Finmore, Bracknell, Berks, RG12 4WF

**CF2 disc printed labels,** £1.10p/25, £2.00p/50, £3.50p/100. Printed index cards for CF2 plastic disc case, £1.00/10, £2.00p/25, £3.00/50. Printed red or blue, please specify (may be mixed). Cheques/P.O.s to Mr S Tonks, Audio & Computing Supplies, Unit 106, 266-290 Wincolmelee, Hull HU2 0PZ

**CPC6128,** built in disc drive, colour monitor, tape deck, single joystick, dust covers, manual and books in mint condition. Quick sale required. £300 ono. Tel: 01-581 2820 (evenings)

**Starstormers,** 20 action packed games in one pack only £5.00. Send SAE for free info or SAE + cheque/P.O. for £5.00 to Anthony Slaven, Starstormers, 20 Freeland Crescent, Priesthill, Glasgow, G53 6PP

**Amstrad CPC6128,** colour monitor, Protex on rom, DMP2000 printer, joystick, magazines, books inc firmware, over £350 software. Altogether worth £1070. Going off £600 (ono). Ring David (0525) 425176 between 5-8.30pm

**Amstrad CPC664 colour for sale.** Also DK Tronics 256KB Ram, joystick, DMP1 printer. Offers for any or all to Pete Noad. Tel 01-740 8383

**100% machine code disc sector editor.** Fast, efficient, friendly. Bargain at £3.00. Send disc plus a self addressed envelope (no stamp) to Niall Brady, Holywell Road, Sligo, Eire. Phone 071 69136

**Quiz race** Hang Man memory character gen for CPC464. All four for £1.99. Send cheques/postal orders to PR Wharton, 93 Silverhill Drive, Fenham, Newcastle. NE5 2JP (tape only)

**Colour 464** 2 x disc drive, DMP 2000 printer, lightpen, speech synthesiser + stereo speakers, joystick, books on Firmware, serious + games software, discs (20). Free delivery can be arranged! All for just £600 (ono). Phone Terry (0885) 718313 after 6pm

**EMR midi interface** and miditrack performer (8-track sequencer for midi keyboards) for disc and tape Amstrads. £75 ono. Tel 0270 627759

**CPC 6128 mono monitor,** new condition, many games, discs, books, magazines, joystick. Best offer over £250. Quick sale Favier 0725 21500 Salisbury Southampton area

**CPC6128 home budget and accounting package.** Fast, efficient, friendly. Full range of facilities. 12 months accounts to each file. £12.50 or SAE for details. T Coard, Waes Hael, Boinhurst, Beds MK44 2EL

**Mono CPC 464** £200 worth of software, books etc. Software includes Marble Madness, J/Nipper 2 £180 ono. Tel Nuneaton (0203) 383165 evenings (Stuart)

**Casio CZ1000 synthesiser** + midi interface, leads and 6128 real time sequencing software, metal concert stand, sixteen voice memory expansion, power supply and amplifier leads. All excellent condition. £295 ono. David (0666) 53807

## WANTED

**Haggard, dead 6128.** Working MP-2, rom boards, roms, Multiface, 5.25" drive etc. Cash waiting. For sale 520STM, meg memory, meg drive, discs £275. Tel David (0292) 541283 evenings

**DMP 2000** in good working order. Will pay £50 + postage. Also protex on rom + rombo. Will pay £20. Phone David (0236) 29808 anytime

## SERVICES

**Discover** how you can start a highly profitable small business from home providing urgently needed business services in your area. No experience or capital required. Unique publication explains the many applications and opportunities available, how to get started, running your business etc. Full details from Avoncliffe (Dept AA), 5 Cliffe Drive, Limpley Stoke Bath, BA3 6HY

**Got World Class Leaderboard (tape)?** Fed up with the putting bug? Send £1 + SAE and blank tape or disc to 33, Church Street, Pembroke Dock, Dyfed, SA72 6AR. For this special poke and playing tips.

**Tape-to-Disc conversions** 464/6128: send original tape(s) plus a disc & 95p per tape (max. 6 tape per disc) and we will transfer them to disc. Compilation tapes 85p each game. If you want the tapes returned add 30p per tape to the total cost. State Whether 464/6128. D R Hudson, 1 Chynoweth, Stenaies, St Austell, Cornwall PL25 4AW. Tel: 0726 850458

**Budget Software** - Special offers: Aliens, Joe Blade, Radius, Knightshade, Alen 2, Knightlore, Professional Skang, BMX Simulator. Three for £5 inc P+P. Parallel Thoughts, 2 The Avenue, Fallings Park, Wolverhampton WV10 0RG

## OTHER

**"Writing software for profit"** - Unique, conceptual and informative publication. The most comprehensive guide available. Excellent value only £4 inc P+P. Parallel Thoughts, 2 The Avenue, Fallings Park, Wolverhampton, WV10 0RG

This section of the magazine offers you the chance to speak directly to the huge waiting world of CPC owners - or would-be owners. Users report good results. You can place an ad of up to 30 words for just £5

So you could use it to sell a printer or launch a user group or publicize a piece of software you've written. One thing you can't advertise is the sale or swap of software. Such ads can be misused by pirates.

Fill in the application form and send it to us together with payment. We'll then place the ad in the next available issue (published 2-7 weeks after we receive your order).

**Order form** Send to: AA Small ads, Future Publishing Ltd, 4 Queen Street, Bath BA1 1EJ

Please place the following advertisement in the next available issue of Amstrad Action

Name \_\_\_\_\_

I enclose payment of £5.00 by Cheque/P.O./Access/Visa.

Address \_\_\_\_\_

Credit Card number \_\_\_\_\_

Credit card expiry date \_\_\_\_\_

Telephone \_\_\_\_\_

Classification:  For Sale  Wanted  Services  User groups  Other \_\_\_\_\_

Write your advertisement here, one word per box. Include your name and phone no. if you want them printed

# The AA Buyers Guide

## The best in sights and sounds

The CPC has tremendous capacity for producing amazing graphics and supper sound. Sadly this isn't always used to its full potential. To get the full impact of the sights and sounds that the CPC can produce you will need one of the many utilities listed here.

### Electric Studio Light Pen

**Electric Studio, £19.95 tape, £29.95 disk**  
A good pen this, with some excellent software. This includes some diverse functions like rubber-banding shapes and lines, filling different areas, spraycan etc. You can write your own software to utilise the pen, although it isn't the easiest task in the world.



### Dart Light Pen

**Dart Electronics, £29.95 tape, £31.65 disk**  
Similar to the Electric studio, but with a fibre-optic lead for better transmission and accuracy. The software isn't quite up to the standard of Electric Studio's: but this is a higher quality product, at a higher price, naturally.

### Dart Scanner

**Dart Electronics, £79.95, reviewed issue 22**  
A novel concept, this. You receive a reading device which you attach to your DMP2000, 3000 or 3160. Feed in a picture to the printer as if you were going to print on it. Then the device reads in the picture to your CPC as a black and white image. Quality of the picture on-screen isn't amazing but it works, it's cheap and fun.

### Advanced Art Studio

**Rainbird, £24.95 disk only, reviewed issue 21**  
Probably the most powerful art package for the CPC, *Art Studio* has yet to have anything come close to it. It will work in all three modes, you can cut and paste different areas, transformations and reflections. Fill routines

will fill in a particular coloured pattern. It's very user-friendly as well. Cycling through the inks is supported as well, and all things considered it is the best art package for the CPCs. 128K of memory needed though.

### AMX Art

**Advanced memory systems, £69.95 (including mouse), disk only**

This is the art program and mouse package. The art program is a little unsophisticated compared to *Advanced Art Studio* but having a mouse to use on an art program really does help. It's got colour, spraycans, textures, circles and a host of other features. Extremely user-friendly.

### CRL Image System

**CRL, £19.95 tape 24.95 disk, reviewed issue 12**

Boasting an array range of picture manipulation this program was designed to give you some real graphical power. Unfortunately it was let down by the lack of art options. Fascinating to see it go to work on finished pictures though.

### AMX 3D Zicon

**Advanced Memory Systems, £39.95 disk only, reviewed issue 24**

Another product that shines with a mouse, 3D zicon can be used to produce wire frame constructions on your computer screen. This is an interesting educational program: designing objects in three dimensions and then viewing them from different angles. The program can produce some impressive displays. It can slow down though when performing a lot of mathematical functions.



### Speech Synthesizer

**Dk/Ram Electronics, £30 tape, £40 ROM**

Thus is an add-on that you plug into the back of your computer. It can then produce speech by means of RSX's, either through its speakers or through your Amstrad. The only problem with using it is that you can't use it to include speech in a program for somebody else's computer. Excellent speech quality, and with the external speakers it's pretty good value.

### Model Universe

**Arnor, £15.95 tape, £19.95 disk, reviewed issue 16**

A similar program to 3D Zicon, *Model Universe* is a 3D design program. Although offering similar features it isn't as user-friendly. Mind you it is cheaper. Interesting to experiment with, and the manual is excellent. *Model Universe* supports the Tandy CGP-115 and MCP40 plotters which can give blueprint of your designs.



### Advanced Music System

**Rainbird, £29.95 disk only, reviewed issue 13**

This program is the best music editor which works with the internal sound chip of the CPC. You can edit a composition in up to three voices, and you can actually edit the tonal quality of the voices. It's also possible to link long compositions together, and they can be printed in stave format, with all those musical shorthand bits - accents, dynamic, accidentals etc.

### Vidi Digitizer

**Rombo Productions, £89.95, reviewed issue 15**

One of the more expensive peripherals, *Vidi* can grab a picture (off of a video recorder or camera) and stick it in your CPC's screen. Then you can play about with it using art packages, etc. *Vidi* is very easy to use, and although not exactly useful it is nevertheless an intriguing piece of machinery. The software is supplied on tape, disk or ROM. It includes a very good printer dump routine.

## Miditrack Performer

EMR, £129.95 cass & disk, reviewed issue 13  
This is a Midi interface, plus some sequencing software to drive Midi equipped instruments such as synthesizers, drum machines etc. It works by recording what you want each instrument to play, and then playing all the instruments at once. It's laid out like a multi-track recorder, and is fairly easy to get to grips with. Excellent if you have a Midi instrument or two, pointless if you haven't. Plus of course it is rather expensive.

## Amdrum

Cheetah, £34.95, reviewed issue 13  
Amdrum is a digital drum machine that is designed to be controlled by an Amstrad. Tape or disk versions are supplied. The editor for Amdrum is pretty comprehensive, if a little plain looking. It is not a Midi compatible instrument. To actually hear the output you have to plug the Amdrum into a separate amplifier.



## EMU

Discovery, £14.95 tape, £19.95 disk, reviewed issue 13.

The Electronic Music Utility is a music editor, similar in some respects to the *Music Studio*. It lacks the printout and link features but does have the facility to play compositions from within your own Basic programs. Good note selection and play facilities, although when changing voices it drags you back to the start of the piece.

## Ram Music Machine

RAM Electronics, £49.95 tape, £59.95 disk

This is an all in one music package. You get a Midi interface, a sound sampler and a music editor. The sampler can handle sounds of just over a second long: however, only one such sample can be held at a time. The music editor is fairly comprehensive, and the Midi controller software is competently done. One problem is that there is no through port, so 464 users will have to use the tape version. Also you can't edit live played Midi compositions.



## Sound Blaster

Siren Software, £29.99, reviewed issue 23  
Simply put, this is an amplifier and a pair of loudspeakers to plug into your Amstrad to deliver more volume and tonal quality to the sound effects. It does this very well, although it delivers a maximum of 2 watts through each speaker - they are capable of taking 20. On the other hand, 20 watts would probably be a dramatic case of overkill. A good product at a reasonable price.

## Silicon Systems Midi Interface

Silicon Systems, £59.95 interface, £59.95 software, reviewed issue 26

Silicon Systems have recently announced that they will not be producing any new CPC products: however they will keep on supplying this one. On its own it's useless, but the range of software for different synths is fairly wide - DX7, FB01, MT32, D50 and CZ101. Software packages vary in price, and they lack the presentation of the EMR sequencer. What they have not got in looks they make up for in performance - they certainly boost the power of your synth.

## Ultra Sound

Siren Software, £14.99 disk only, reviewed issue 29

Well, there has to be one sound effects package, and this is it. It can sample up to a minutes worth of sound, you can edit it, speed it up and slow it down. There is also a section in which to design your own sound effects. All the sound you create can be used from within your own programs. Very good, although it isn't a music editor.

## Parrotty Plus

Treasure Island Software, £19.95, disk only, reviewed issue 30

A novel approach to creating graphic art has been implemented. Rather than having a lot of effects which can be used anywhere and any time to create a finished product, *Parrotty Plus* remembers every alteration that you make to the screen. You can then play through it to create an animation sequence. Not easy to understand at first, but you soon get into the program. Also you can't dump pictures to a printer without an external program.

## The Informer

Treasure Island Software, £29 disk only, reviewed issue 33

This program can be used to create animated displays, suitable for use in a classroom or a shop window. It works best with *Parrotty Plus*, but other art packages can be used at a disadvantage. *Informer* takes all the text, graphics and animated displays and then produces a slide show to taste. Its amazing what this treatment can do in terms of presentation of a dull subject.

## Contacts

EMR, ☎ 0702 335747, 14 Mount Close, Wickford, Essex

RAM Electronics, ☎ 0252 850085, Unit 16, Redfields Industrial Park, Redfield Lane, Church Crookham, Aldershot, Hants GU13 0RE

Silicon Systems, ☎ 061 848 8959 Trafford Technology Centre, 43 Elsinore Rd, Manchester, M16 0WG

Microtext Ltd, ☎ 0705 595694, 7 Birdlip Close, Horndean, Hants, PO8, 9PW

Siren Software, ☎ 061 228 1831, 2-4 Oxford Road, Manchester, M1 5QE

Treasure Island Software, ☎ 0492 530229, 140 Llanwurst Rd, Colwyn Bay, Clwyd, LL28 5YL

DHCP, ☎ 0440 61207, 32 Boyton Close, Haverhill, Suffolk, CB9 0DZ

Electric Studio, ☎ 0462 420222, Unit 8, Cam Centre, Wilbury Way, Hitchin, SG4 0TW

Dart Electronics, ☎ 0502 513707, Unit B5, Oulton Works, School Rd, Lowestoft, Suffolk, NR33 9NA

Rombo Productions, ☎ 0506 39046, 107 Raeburn Rigg, Livingston, EH54 8PH

Advanced Memory Systems, ☎ 0925 413501, 160/170 Wilderspool Causeway, Warrington, WA4 6QA

Cheetah Marketing, ☎ 0222 555525, Norbury House, Fairwater, Cardiff, CF5 3AS

Discovery/Gremlin Graphics, ☎ 0742 753423, Alpha House, 10 Carver Street, Sheffield S1 4FS

Arnor, ☎ 01 684 8009, Protext House, Wainman Rd, Peterborough, PE2 0BU

Rainbird Software, ☎ 01 240 8838, Wellington House, Upper St Martins Lane, London, WC2H 9DL

CRL, ☎ 01 533 2918, CRL House, 9 Kings Yard, Carpenters Road, London E15 2HD

## DHCP Midi Interface

DHCP, £49.95 interface, £29.95+ disk software, reviewed AA33

DHCP produce their own Midi interface, which is up to scratch as far as it goes. However, they also have a policy of bringing out their Midi software for all the various Midi interfaces for the CPC's, which are incompatible with each other. These included an 8 Track Sequencer, Casio CZ voice editor and FB01 editor, and considering they are the lowest priced Midi software packages they are good value.

## Bath Computer Shack

8e Chelsea Road, Bath (0225 310300)

Often we find that to review a music package we need to scrape up a synth or two. Bath Computer Shack kindly lend us instruments from time to time, and without their help we couldn't give you those opinions and descriptions that make a good review.

**Q.** Which new games software is alluring, addictive, AA raved and - amazingly enough - available absolutely free of charge on cassette or disk?

**A.** Any one of these titles when you subscribe to ***Amstrad Action***.

Incredible but true. Subscribe to the leading magazine for Amstrad CPC owners and we'll send you your choice of one of the programs on the opposite page for nothing. That means up to £14.99 worth of software free of charge for disk owners. And people who ask for the *cassette* version of the game will *also* get a free copy of the famous epic *Shadowfire* (RRP £9.95), making their saving almost £20.

A 12-issue subscription to Amstrad Action costs £16.50, and guarantees a year's supply of your favourite magazine delivered hot off the press direct to your door.

To order, just turn the page and fill in the form, or dial 0458 74011 with your credit card details.

### EXTRA SUBSCRIPTION GIFT FOR CASSETTE USERS!

As if one free game wasn't enough, here's another: a free copy on cassette of the huge, multi-character epic *Shadowfire*. This superb game from Beyond, by master programmer Mike Singleton, was one of the first CPC games to feature icons in the playing. Icon and multi character gameplay means hours of enjoyment - but you'll need patience too! Set in a spaceship, you control six dubious characters as they try to complete a mission to capture or destroy an enemy spaceship, and take its commander alive.

We'll include it as a bonus to every new subscriber who opts for the *cassette* version of one of the other games highlighted on this page. (Sorry, disk users, but you're getting an expensive enough gift as it is!)

### HOW TO ORDER

Just turn the page and use the order form (the order codes are listed next to the form).

Or telephone us with  
your credit card details on

**0458 74192**

(24-hour answerphone).

### A VERY SPECIAL OFFER!

### **Amstrads and Artificial Intelligence**

by **Patrick Hall**

**Now just £1.95 (RRP £8.95!)**

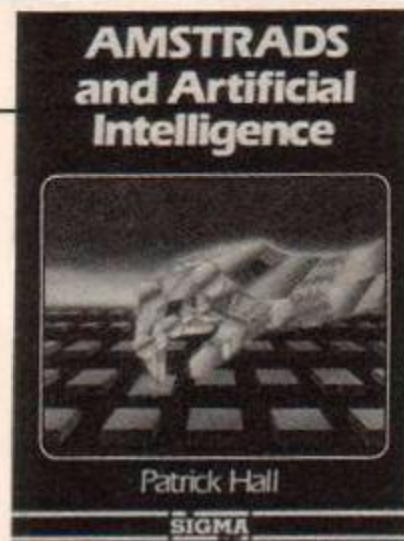

Published by Sigma Press, this book looks in detail at one of the most talked-about topics of our generation - artificial intelligence. Is it really possible to build a computer program that comes anywhere near the capabilities of the human brain?

*Amstrads and Artificial Intelligence* isn't a philosophy book though - it's a book that discusses the requirements of AI AND offers several program listings that allow you to start tackling the issues at the practical level. Didn't think you could get AI on your CPC? Well think again - then buy this book. Topics include expert systems, computer vision, robots and learning, game playing and knowledge representation. All this for just £1.95 - saving **SEVEN POUNDS** on the original price!!! An excellent book for anyone who owns a CPC and wants to explore it further than ever before.

**Order Code A895**

# ANY ONE OF THESE PROGRAMS **FREE** WHEN YOU SUBSCRIBE!

Or buy them separately for the special price of £6.95 cass, £11.95 disk.

## PLATOON

Normal shop price  
£9.99 cass, £14.99 disk

The game of the film now on the CPC range!

• Ocean's version is totally over the top!

• Warning! This game may require you to engage minute portions of your brain!

• Six levels of sickening slaughter!

• Free plus - Smokey Robinson's Tracks of my Tears

• AA Rave - May '88 issue

## ARKANOID II

Normal shop price £8.95  
cass, £14.995 disk

• AA Rave from Ocean.

• Superb, even faster, more capsules, more response

• *Breakout* clone of course!

• 64 screens to bust your way through!

• The ultimate in clean lean entertainment.

• Be a star!

• Reviewed May '88 issue

• Going going gone!

## SPY VS SPY TRILOGY

Normal shop price £9.95  
cass, £14.95 disk

• From First Star, three games together to set your CPC alight!

• Pure thrills'n spills as made famous in the MAD cartoons

• AA Rave in May issue of AA

• One or two player option

• Amazing split screen horizontal scrolling technique

• Mind the bombs, springs, water buckets, guns and a time bomb!

## DEFLEKTOR

Normal shop price £9.99  
cass, £14.99 disk

• AA Mastergame from Vortex

• A game of fast, logical thought

• Destroy the cells dotted

round the screen with a laser

• Then line the beam up on a receiver.

• Your mind will be fried before you get there!

• Gremlins won't let you get away lightly! 90% in AA March 1988

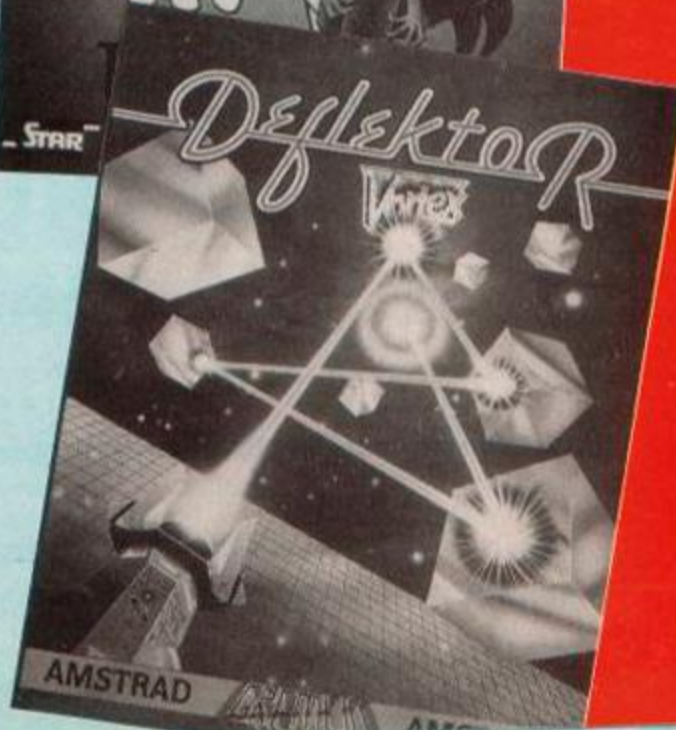
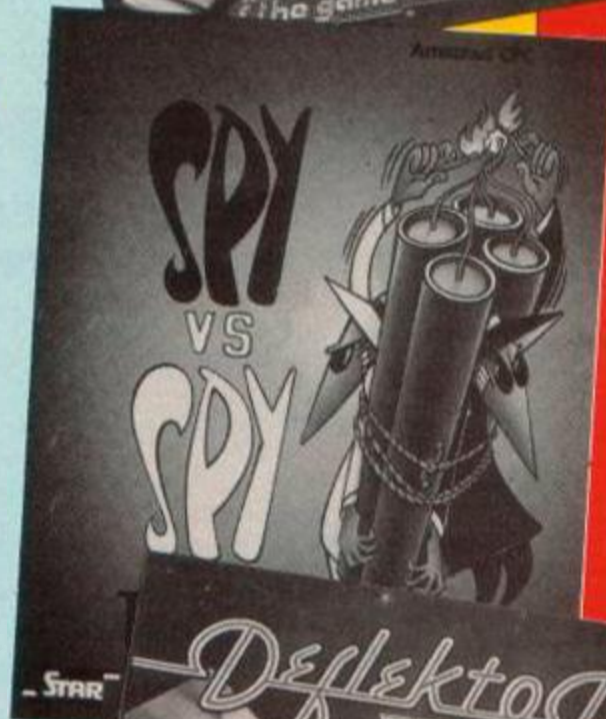

# SPECIAL OFFERS

## HIGHLIGHTER PENS

Three for £1.50

Anyone who uses computers a lot, can make use of highlighter pens. For marking the important lines in a document or printout or program listing. For ensuring a key sentence in a manual isn't forgotten. Or just for highlighting the main points in an Amstrad Action article.

We're offering a set of three different-coloured AA-stamped pens in a clear plastic wallet for just £1.50. They're high-quality and long-lasting. A good way of focussing attention on things that matter.

## MAGAZINE BINDERS

Only £4

Amstrad Action is a magazine worth collecting, and our sturdy, custom-built binders provides the best way of keeping your collection tidy and in good condition. Each one is designed to hold 12 copies of AA and preserve them for posterity - and easy future reference.

As well as being functional, the binders look every bit as good as the magazine. They're coloured a smart royal blue with the magazine logo printed in blocked Newvap Gold on the spine and front. Individual magazines are held in place by one of 12 wires.

Buy one and you can have a year of CPC info at your fingertips.



## BACK ISSUES

Expand your Amstrad Action collection

If you're one of the thousands of readers who've joined the club, catch up on some of the good things you've missed. Here are some of the back issues listed below, which we're selling at a special price. Issues 8 and 16 may be of particular interest, as both contain software. Two series also went down very well. And for absolute beginners ran from issues 8-17, while a series for experienced users ran from 10-17. All issues contain numerous game reviews.

- ISSUES 8-17
- ISSUE 15
- ISSUE 16
- ISSUE 17
- ISSUE 18
- ISSUE 19
- ISSUE 20
- ISSUE 21
- ISSUE 22
- ISSUE 23
- ISSUE 24
- ISSUE 25
- ISSUE 26
- ISSUE 27
- ISSUE 28

Send this form plus payment to: AA Mail Order, The Old Barn, Somerton, Somerset, TA11 7PY

### ORDER FORM

Name.....Telephone no. (if poss).....

Address.....

.....Post code.....

Machine owned:  CPC 464  CPC 664  CPC6128

Please send me the following items from the Amstrad Action special offer pages.

ORDER CODE	DESCRIPTION	PRICE

TOTAL PAYABLE

Please circle your method of payment: ACCESS • VISA • CHEQUE • PO

Make cheques + postal orders payable to FUTURE PUBLISHING LTD. If paying by credit card, please enter details:

CREDIT CARD NUMBER  EXP. DATE

## • USE THESE

Details of these products are given on page 10

ITEM	OUR PRICE	ORDER CODE
<b>SUBSCRIPTION</b>		
with PLATOON cass*	£16.50	A300
with PLATOON disk	£16.50	A301
with BUBBLE BOBBLE cass*	£16.50	A302
with BUBBLE BOBBLE disk	£16.50	A303
with DEFLEKTOR cass*	£16.50	A304
with DEFLEKTOR disk	£16.50	A305
with ARKANOID II cass*	£16.50	A306
with ARKANOID II disk	£16.50	A307
*Cass options include Shadowfire on tape as free extra		
PLATOON CASS	£8.95	A308
PLATOON DISK	£11.95	A309
BUBBLE BOBBLE CASS	£6.50	A310
BUBBLE BOBBLE DISK	£11.95	A311
DEKLEKTOR CASS	£6.95	A312
DEFLEKTOR DISK	£11.95	A313
ARKANOID II CASS	£6.95	A314
ARKANOID II DISK	£11.95	A315



# THE THINGI

Only £5.95 – save £2!

What's white, dangles paper next to your computer screen, and costs two pounds less than in the shops? Yes, a Thingi bought through Amstrad Action.

This remarkable computer accessory – an idea so simple it's ingenious – could dramatically ease your hours at the keyboard. It's basically a cleverly-shaped piece of plastic that attaches via Velcro to the top of your micro. But with a Thingi on your CPC you can have documents, letters or program listings clipped right next to the screen in perfect reading position.

Any task involving copying off paper is thereby made much easier and faster. In fact, the coloured clip supplied is sturdy enough to support an issue of Amstrad Action open, say, at the Type-ins section.

The Thingi comes in two versions, one for positioning to the left of the screen, the other to the right – the Velcro attachment allows easy readjustment or temporary removal.

A sensible, cost-effective add-on for your CPC.



## DISK BOX!

Only £12.95 – including free blank disk!

This will do for your disks what an AA binder does for your AAs. Keep 'em tidy. The box is made from top-quality perspex and features a tinted, hinged, lockable lid.

It's specially designed to take Amstrad 3" disks and will hold and display 20 including their cases or 40 without cases. A set of 20 dividers included with the box can be used to lay your hand instantly on the disk you need. A classy way to keep your worktop organised.

## AA DUST COVERS

2-piece set only £6.95

Let's face it, computers don't like dust. Over a period of time it can make them very ill indeed; disk drives and cassette decks in particular can suffer serious, sometimes fatal damage.

A set of dust covers provides a neat solution. And there's the added bonus of smartening up the hardware's appearance when it's not in use.

The specially-commissioned Amstrad Action covers are made from high-quality, water (and coffee) proof PVC. They're coloured a gentle beige with smart blue trimming and matching AA logo.

You can order a 2-piece set tailor-made for your CPC system – just choose the correct order code from the list next to the order form.

## ORDER CODES

here and on the preceding pages

ITEM	OUR PRICE	ORDER CODE
<b>AA DUST COVERS</b>		
CPC 464 mono	£6.95	A208
CPC 464 colour	£6.95	A209
CPC 664 mono	£6.95	A210
CPC 664 colour	£6.95	A211
CPC 6128 mono	£6.95	A212
CPC 6128 colour	£6.95	A213

<b>THINGI</b> left-of-screen	£5.95	A214
right-of-screen	£5.95	A215

<b>DISK BOX</b> (with free disk)	£12.95	A216
----------------------------------	--------	------

<b>AA BINDER</b>	£4.00	A217
------------------	-------	------

<b>3 AA HIGHLIGHTER PENS</b>	£1.50	A266
------------------------------	-------	------

### AA BACK ISSUES

For issues 10-26 use codes AA11-26. The price of each issue is listed in the Back Issues panel on this page.

### SPECIAL OFFER

Master Machine Code on your Amstrad CPC 464 & 664 ..... Order code A284

## 24-HOUR HOTLINE

☎ 0458-74192

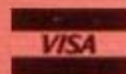

If you own Access or Visa credit cards you can place your order by telephone at any time of day or night, seven days a week. Just dial 0458-74192 and be ready with your name and address, credit card number and expiry date, and the details of the software you wish to order. Alternatively, if you prefer a human being to an answerphone, you can ring 0458-74011 during office hours and ask for "Credit Card Orders".

# REARVIEW

A sideways look at the world of computing, plus NO Sugarman

## Double trouble

What have we here? Could it be yet another wacky publicity shot from Codemasters? This time they've forsaken the Darling boys on a bike and put the Oliver twins up a tree. They're obviously hard at work researching a new game - *Special Branch Simulator*.



## Great disasters

We don't normally talk about other people's computer magazines, but we couldn't resist telling you about what happened to the producers of "Amiga Computing". Their launch issue



However, we still got a letter from someone who thought we hadn't done it deliberately. Just shows what a high opinion some readers have of us. So remember, the next time you spot a headline missing, it's not a cock-up - it's creative use of white space.

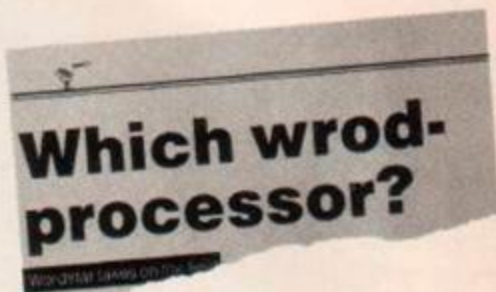
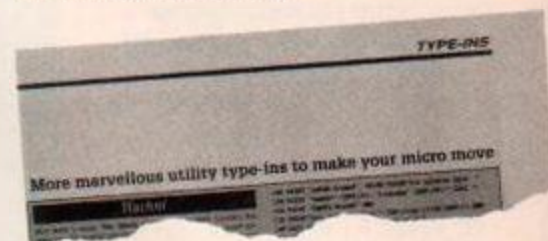

was printed with the word "computing" entirely missing from the cover. Doubtless heads rolled for that one. On the cock-up scale it ranks alongside those perpetrated by our good selves when we left the headlines of the Reaction and Type-Ins sections.



However, none of them can quite compare with the double-bluff that occurred in our first issue. We printed a comparison of word-processors with the headline "Which wrod-processor?" in letters so large Eddie Edwards couldn't have missed them while proofreading.

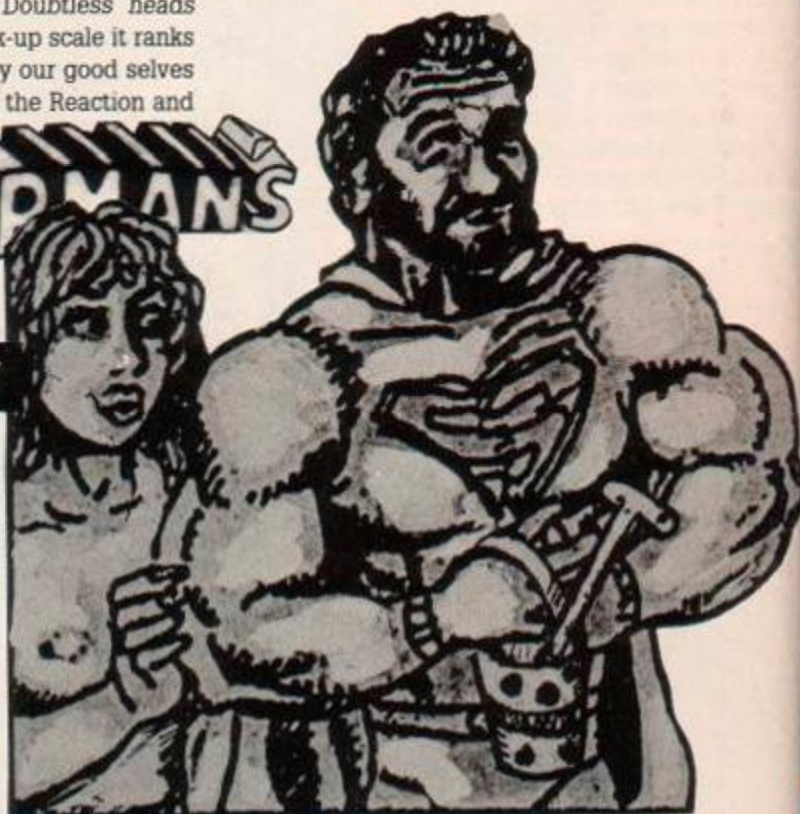

## ADVERTISING INDEX

AEL .....	64	D&H .....	42	John Morrison .....	26
Arnor .....	6	EMM .....	35	Nemesis .....	26
BBD .....	64	E&J .....	35	Ocean .....	IFC,3,47
Budgetsoft .....	64	Goldmark .....	18	Prism .....	15
Castle .....	11	KDS .....	52	Romantic Robot .....	48
Compumart .....	29	K&M .....	26	SDC .....	58
Comsoft .....	42	Luds .....	52	Siren .....	35
Connect .....	64	MJC .....	36	US Gold .....	IBC,OBC
				Wacci .....	52

# SUPERCHARGED DESTRUCTION

# ROAD BLASTERS™

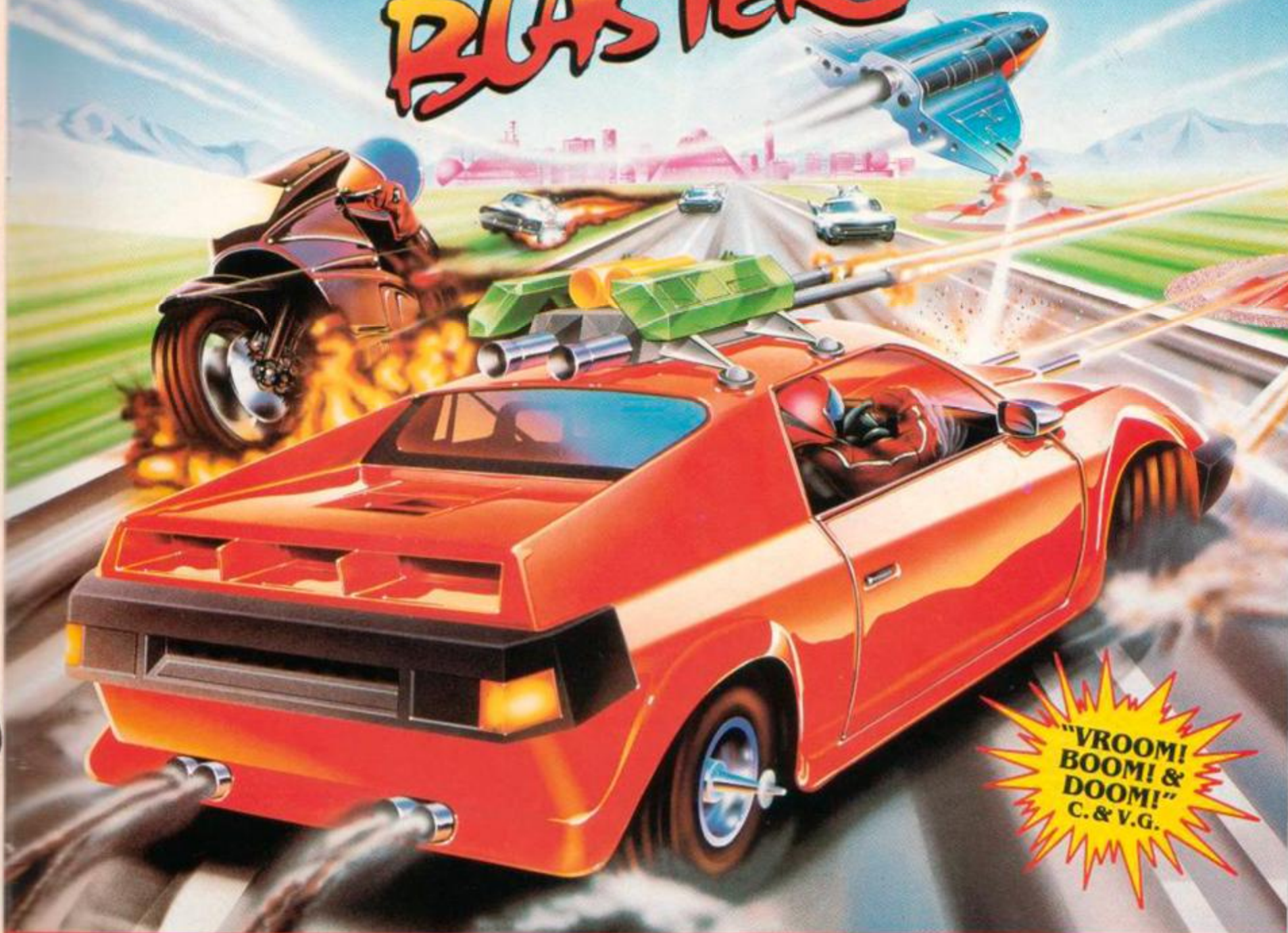

**"VROOM!  
BOOM! &  
DOOM!"**  
C. & V.G.

Screen shots from CBM version.



The thunderous world of destruction .... the ultimate race against death, Roadblasters delivers all the gripping action and high speed thrills of the arcade spectacular.



**CBM 64/128**  
**£9.99t - £14.99d**  
**SPECTRUM 48/128K**  
**£8.99t**  
**SPECTRUM +3**  
**£12.99d**



**AMSTRAD**  
**£9.99t - £14.99d**  
**ATARI ST AMIGA**  
**£19.99d £24.99d**



© 1986 Atari Games Corp.  
Licensed to U.S. Gold Ltd.  
All rights reserved.

U.S. Gold Ltd., Units 2/3 Holford Way, Holford, Birmingham B6 7AX. Tel: 021 356 3388.

# STREET FIGHTER

... NOTHING STANDS IN YOUR WAY

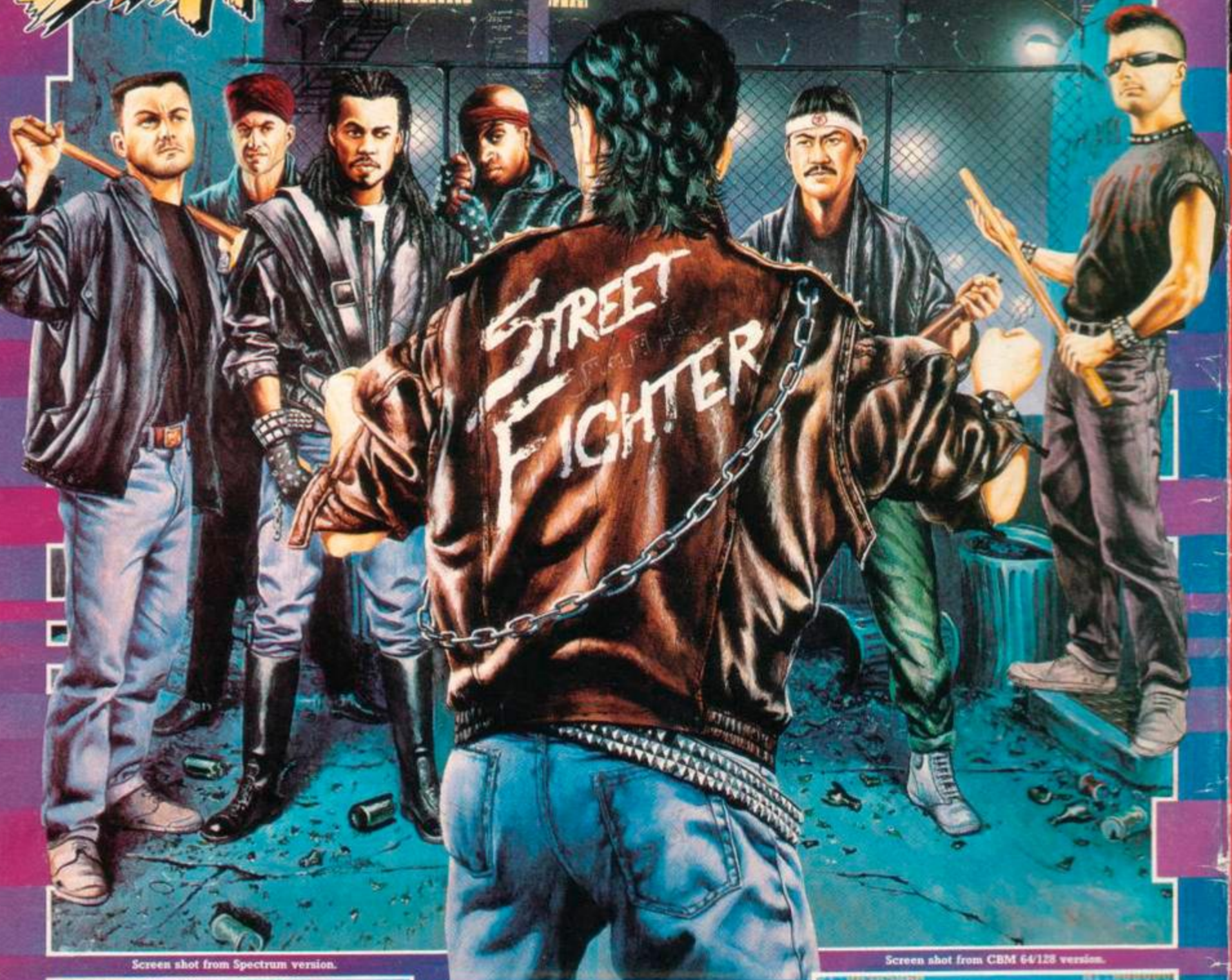

Screen shot from Spectrum version.

Screen shot from CBM 64/128 version.



Screen shot from Amstrad version.



## EXPLOSIVE COIN-OP ACTION!

Battle your way across the globe taking on the mighty fighting power of 10 awesome exponents of hand to hand combat.

*"A SINCLAIR CLASSIC"*

*"Thoroughly impressive combat game which knocks Renegade for 6. Go damage someone."* Sinclair User

*"It's fast, good looking and well hard"*  
Your Sinclair



Screen shot from Atari ST version.

- CBM 64/128 **£9.99t - £14.99d**
- Spectrum 48K **£8.99t**
- Spectrum +3 **£12.99d**
- Amstrad **£9.99t - £14.99d**
- Atari ST **£19.99d** Amiga **£24.99d**



GIANTS OF THE VIDEO GAMES INDUSTRY



CAPCOM U.S.A., Inc. © 1987